

Directions: Take turns flipping a coin.

Heads=Move 1 space

Tails=2 spaces

Use two other coins as playing pieces. Before a player can move ahead, he or she must say the correct shape AND the correct number. The first one to the end is the winner.

Key





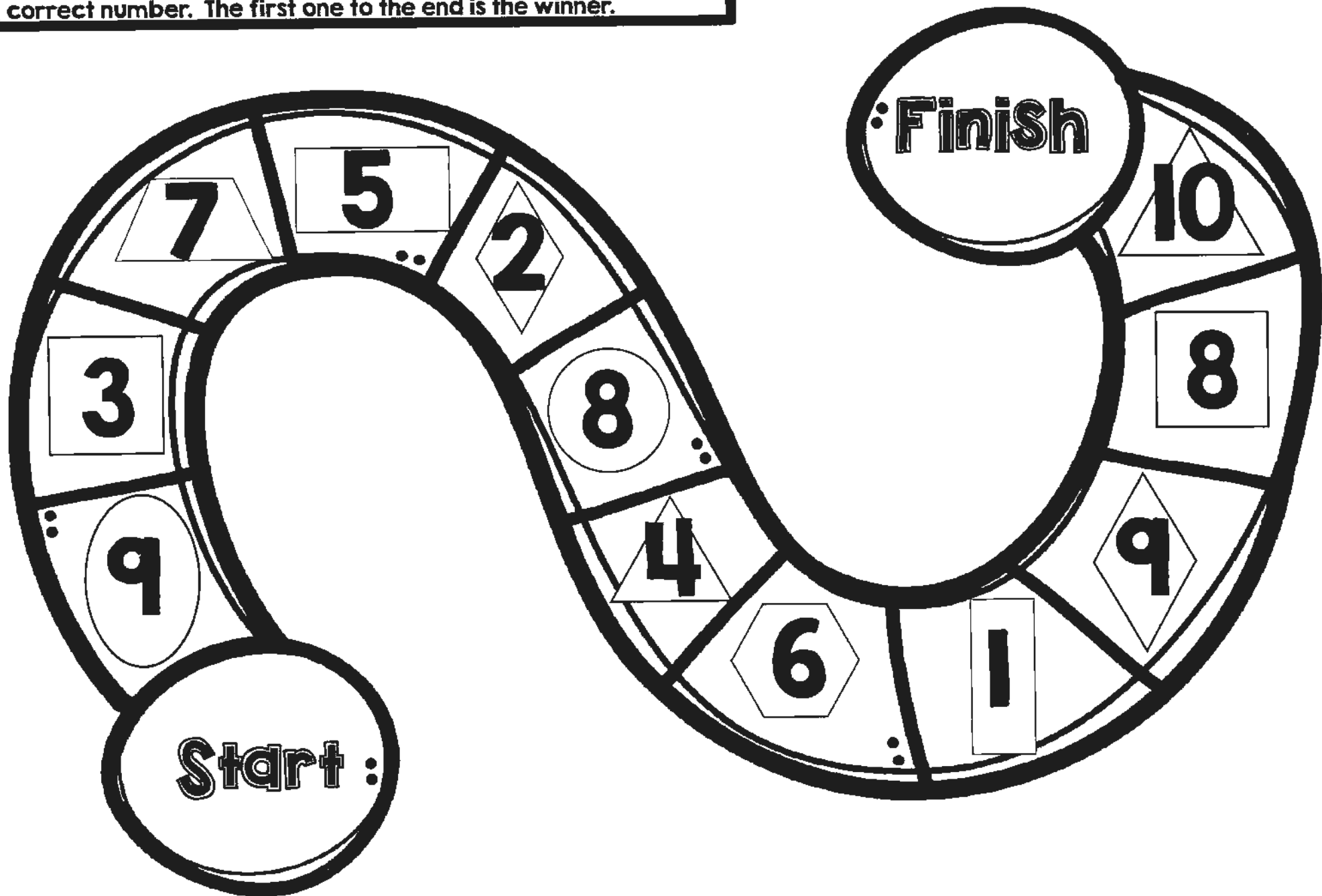

rhombus trapezoid hexagon



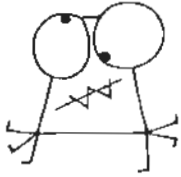

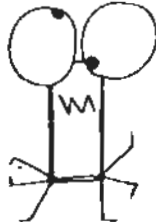



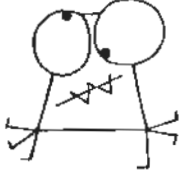

Monster Mash

Directions: Toss a coin in the air. Heads=Move 3 spaces Tails=Move 2 spaces. Use two other coins as playing pieces. Before moving to the letter he or she must say the letter. If you land on a monster go back 5 spaces. For more of a challenge, have your child say something that starts with that letter. The first one to the end is the winner.

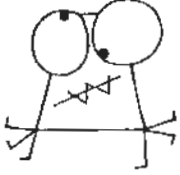
| | | | | |
|---|---|---|---|--------|
| ↑ h |  | q | w | END |
| r | y | g | n | l ↑ |
| ↑ f | z |  | k | c |
|  | m | b | a | t ↑ |
| ↑ z | s | p |  | o |
| ↑ e | v | j | d | i ↑ |
| START | x |  | u | l ↑ |



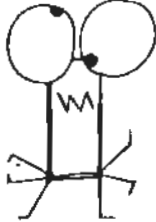







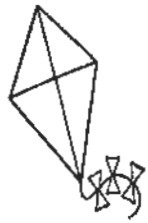

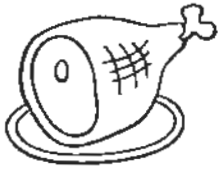

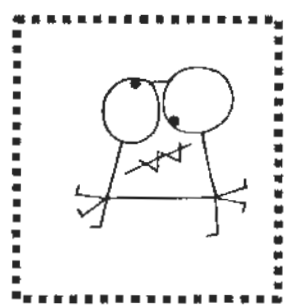

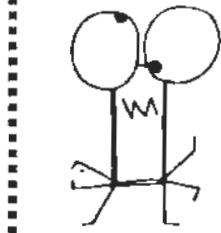

Monster Mash

Directions: Toss a coin in the air. Heads=Move 3 spaces Tails=Move 2 spaces. Use two other coins as playing pieces. Before moving to the letter he or she must say the letter. If you land on a monster go back 5 spaces. For more of a challenge, have your child say something that starts with that letter. The first one to the end is the winner.

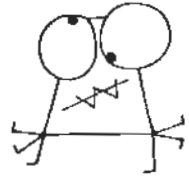
| | | | | |
|---|---|---|---|--|
|  H |  | Q | W | END |
| R | Y | G | N | I  |
|  F | Z |  | K | C |
|  | M | B | A | T  |
|  Z | S | P |  | O |
| E | V | J | D | I  |
| START | X |  | U | L |

Monster Mash

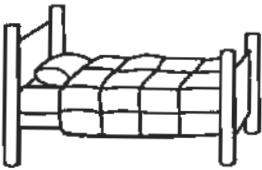
Directions: Toss a coin in the air. Heads=Move 3 spaces Tails=Move 2 spaces. Use two other coins as playing pieces. Before moving to the space he or she must say the letter that is at the beginning of the word. If you land on a monster go back 5 spaces. The first one to the end is the winner.

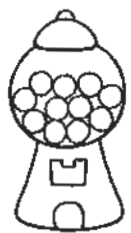
| | | | | |
|---|---|---|---|--|
|  ↑ |  |  |  | End |
|  |  |  |  |  ↑ |
|  ↑ |  |  |  |  |
|  |  |  |  |  ↑ |
| START |  |  |  |  ↑ |

Letter

Name _____

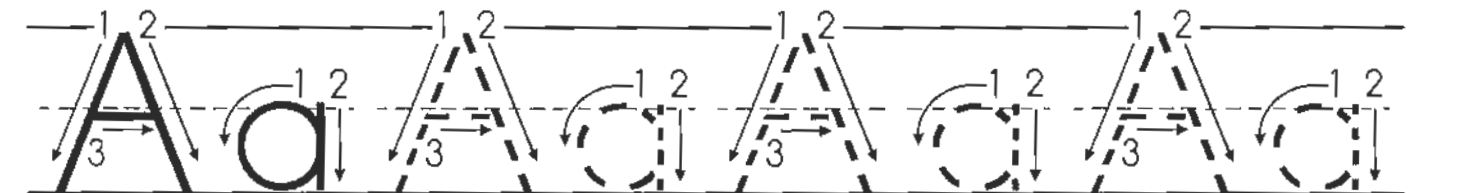
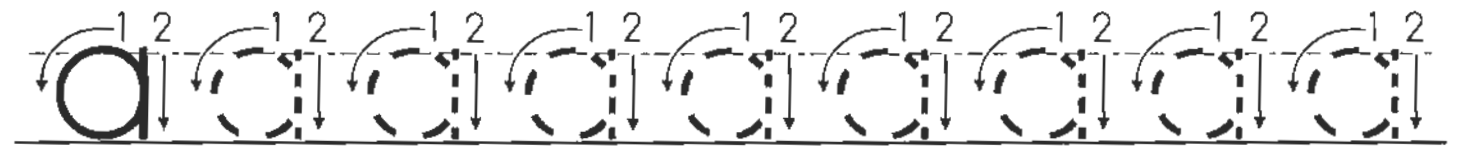
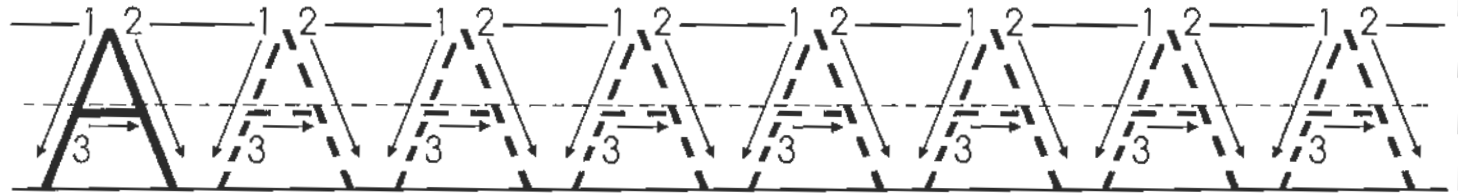
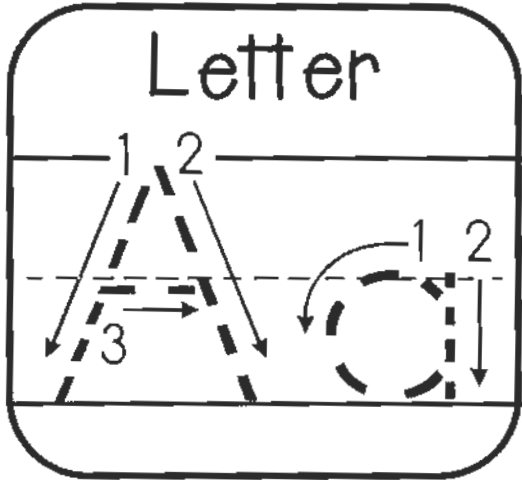

Letter

Name _____

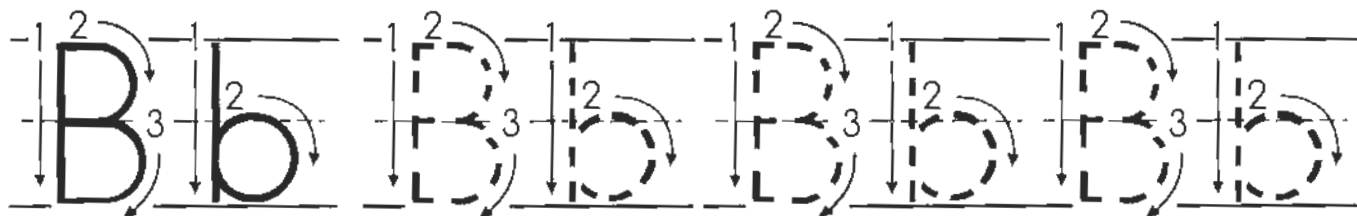
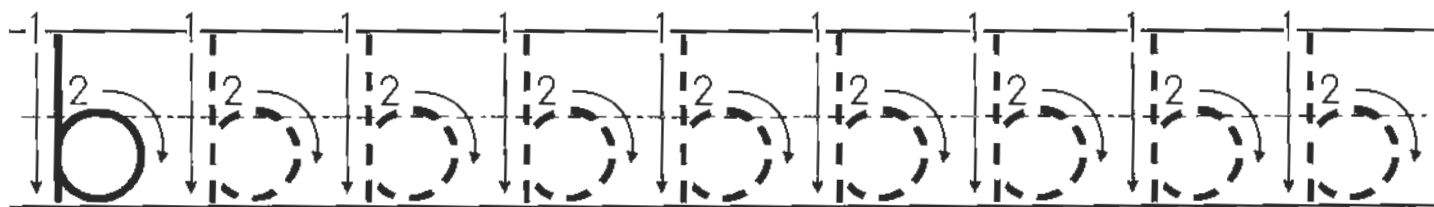
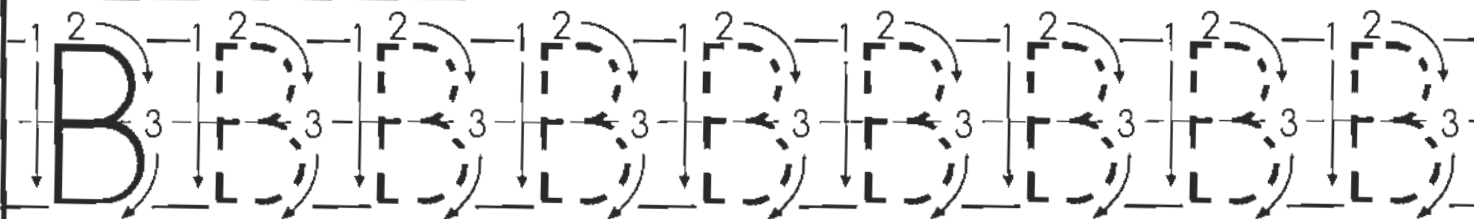
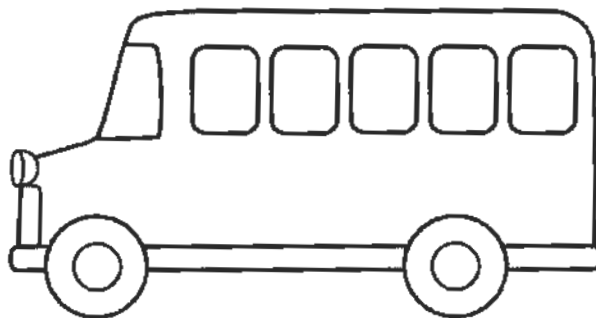
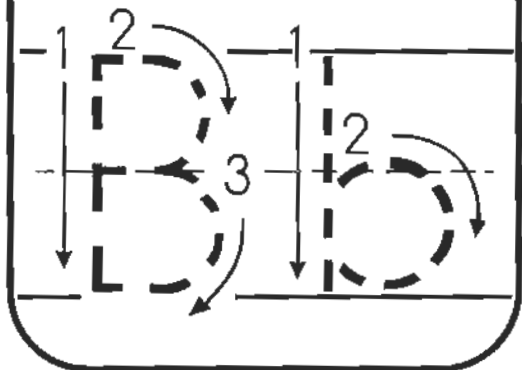

Letter

Name _____

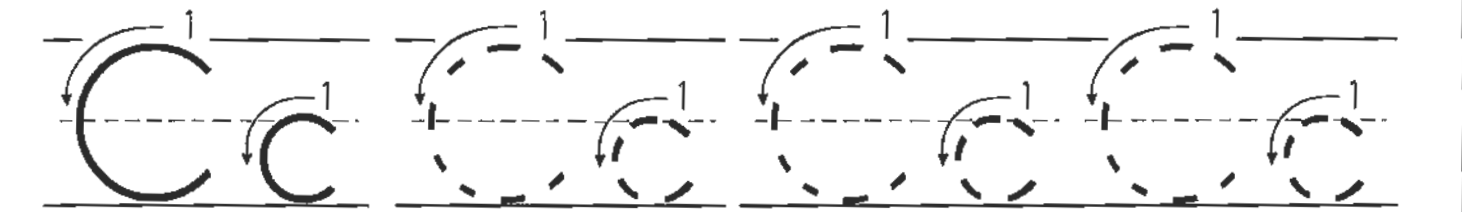
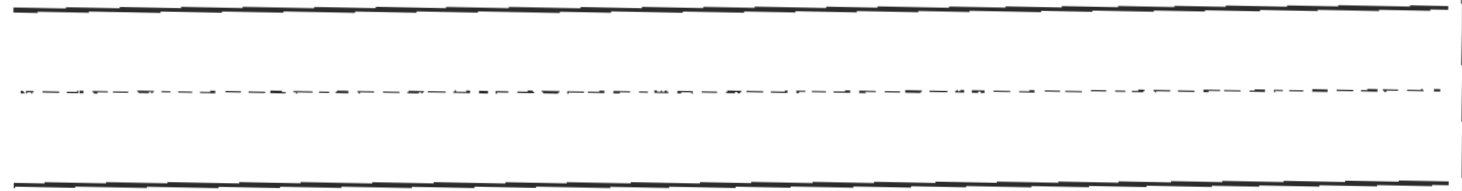
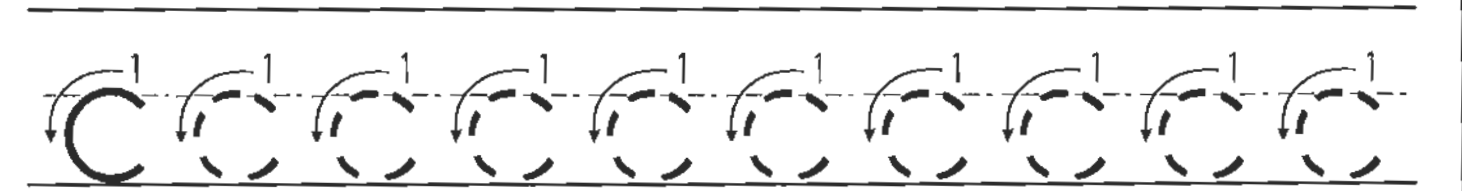
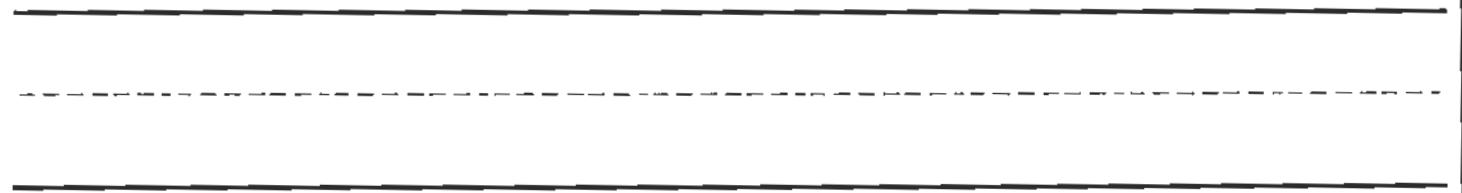
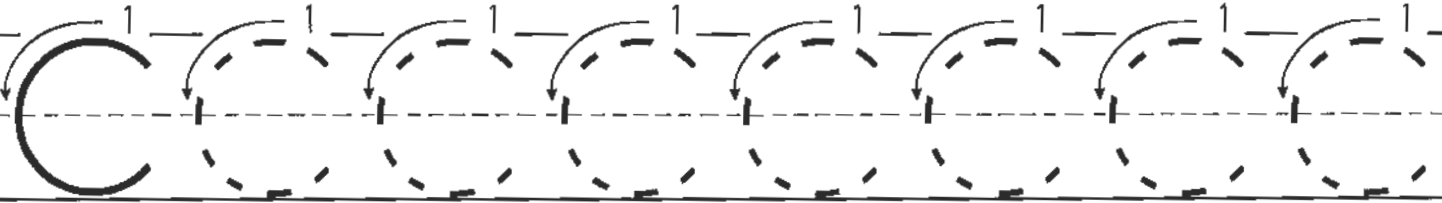
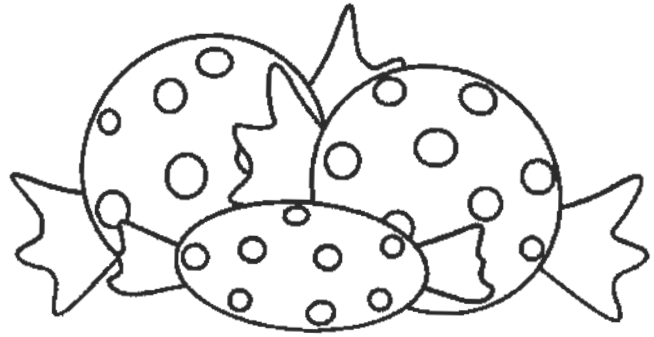
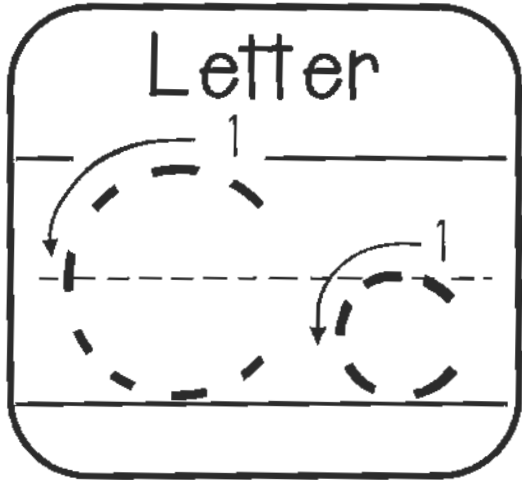

Letter

Name _____

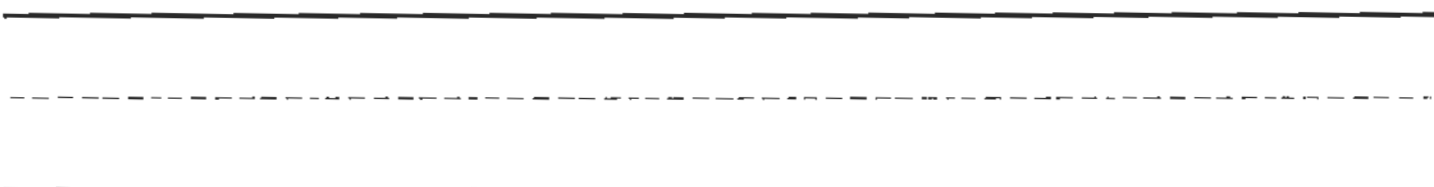
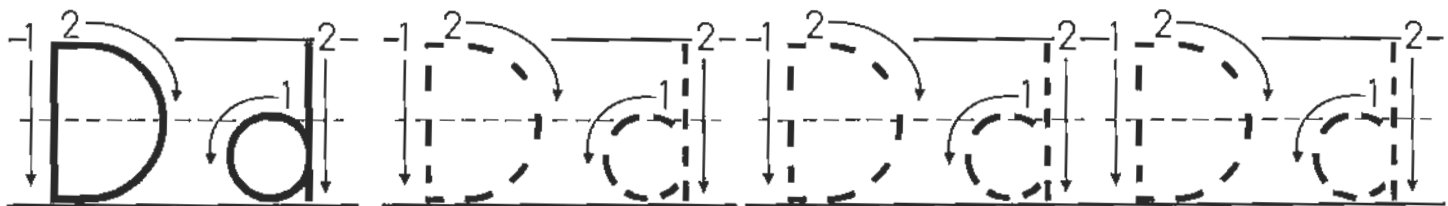
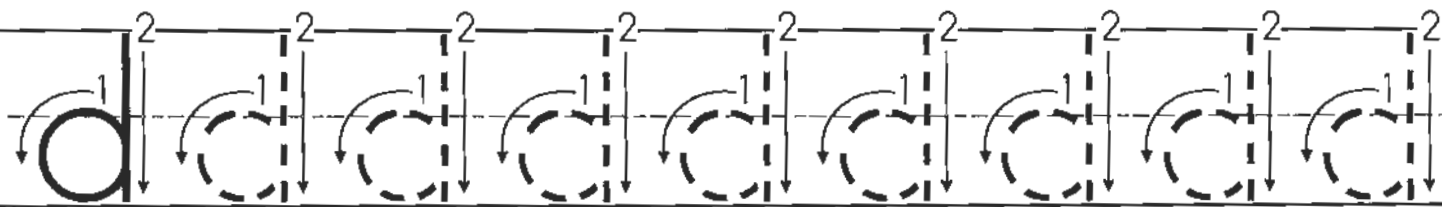
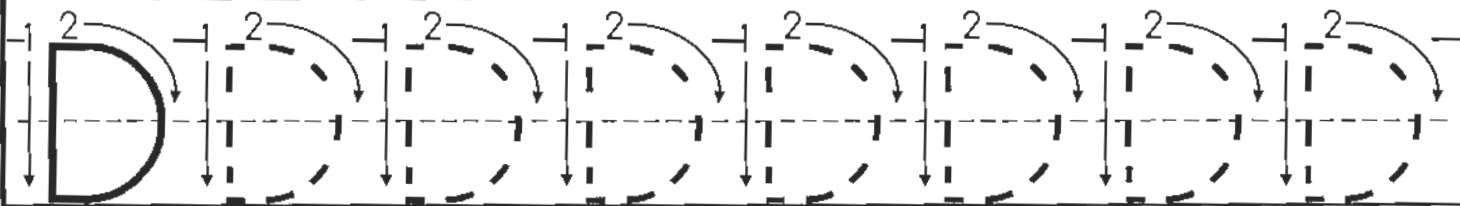
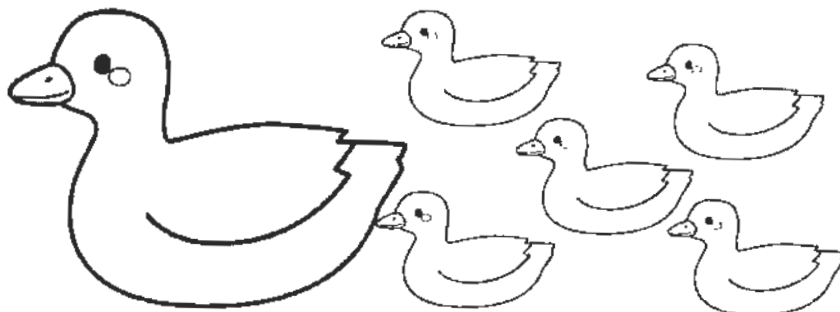
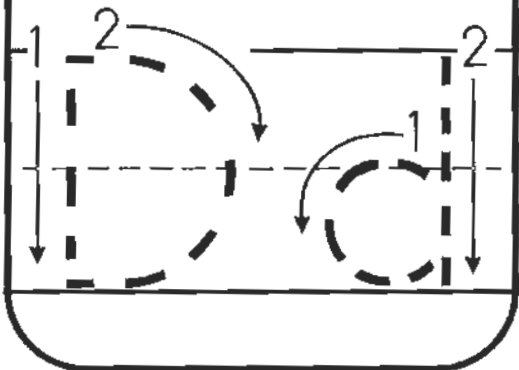

Letter

Name _____

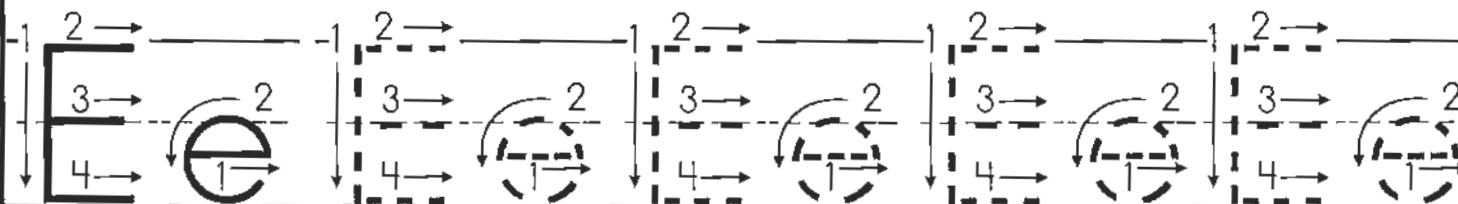
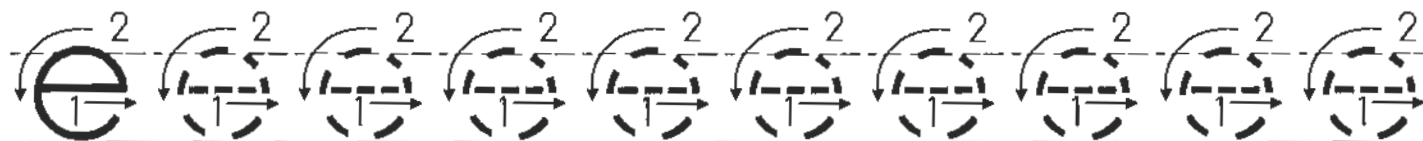
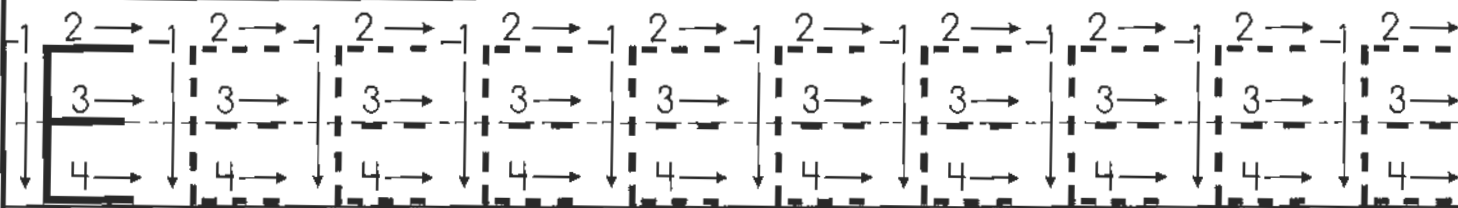
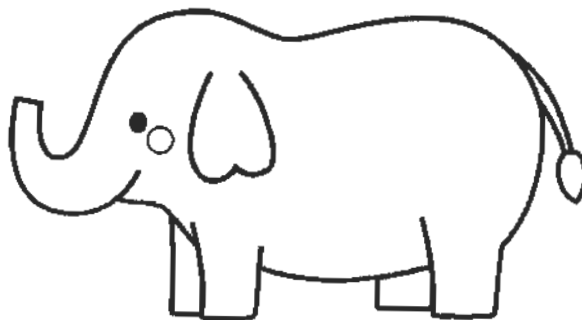
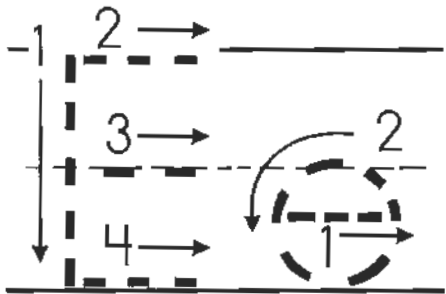

Letter

Name _____

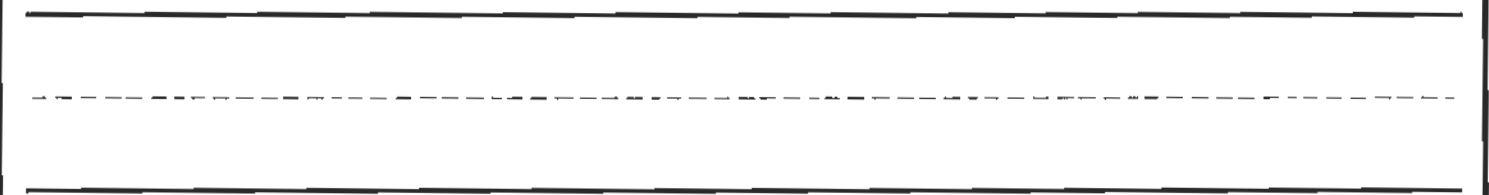
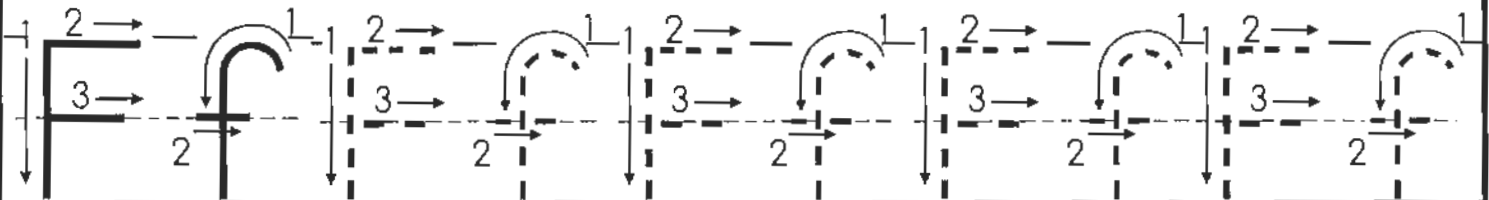
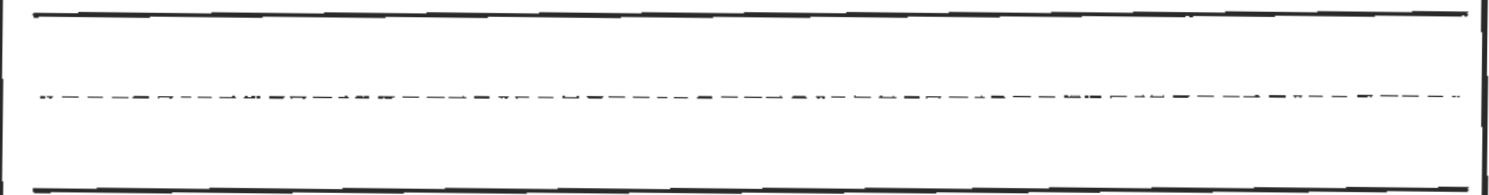
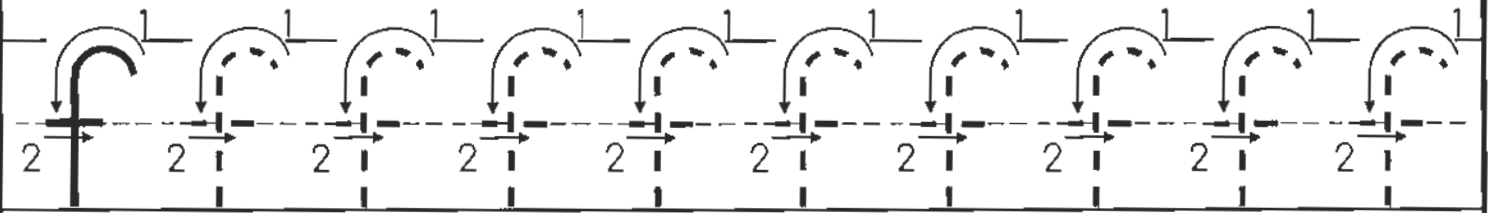
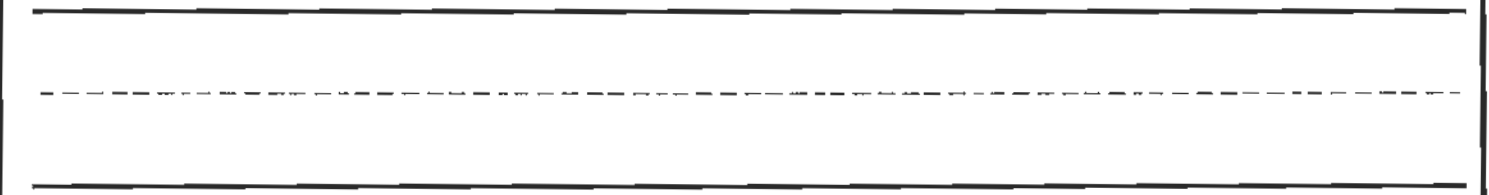
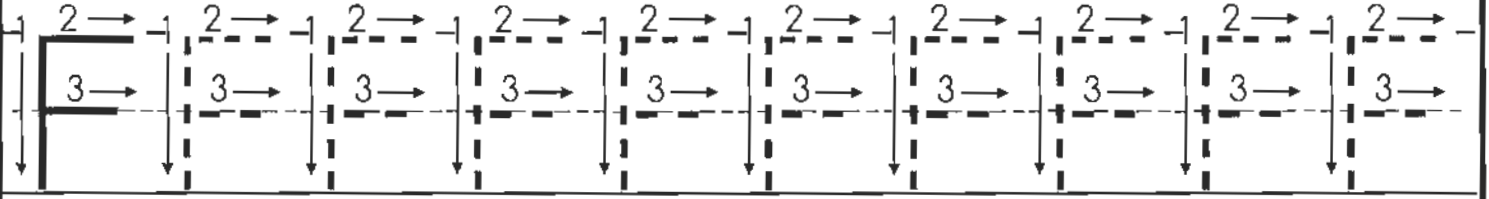
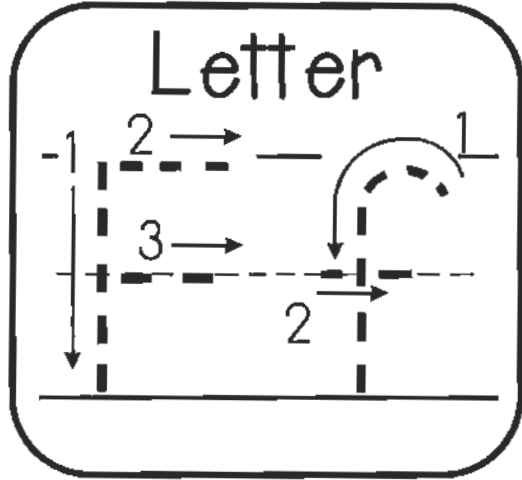

Letter

Name _____

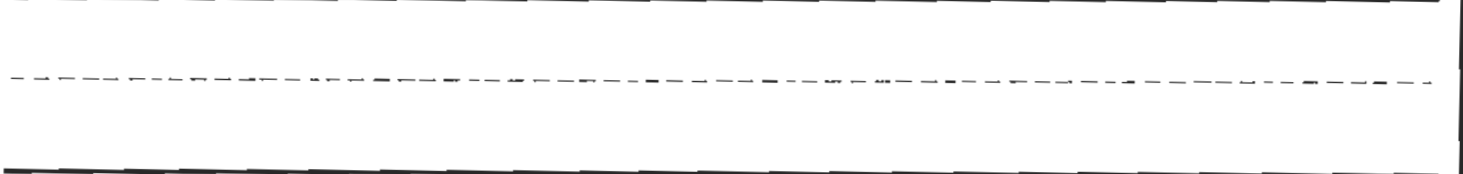
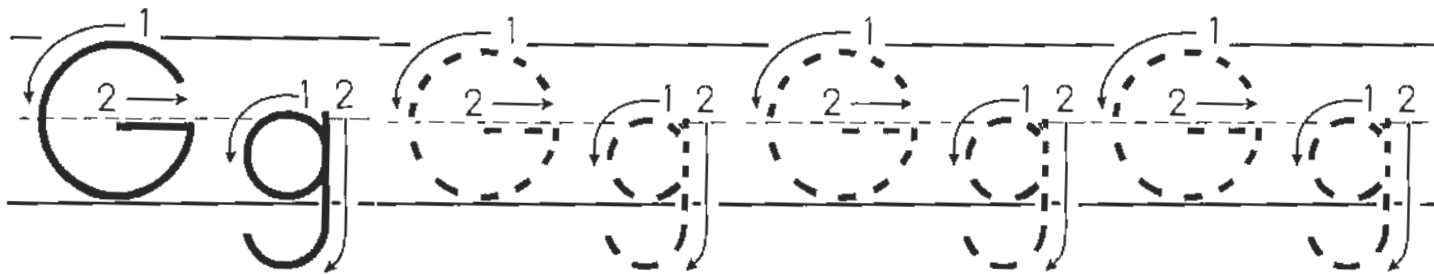
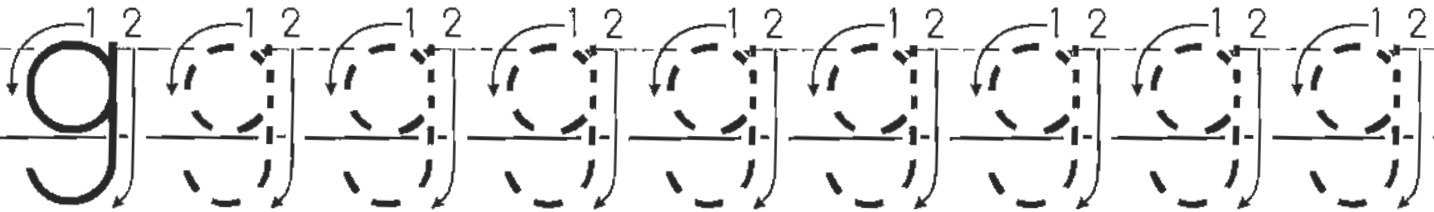
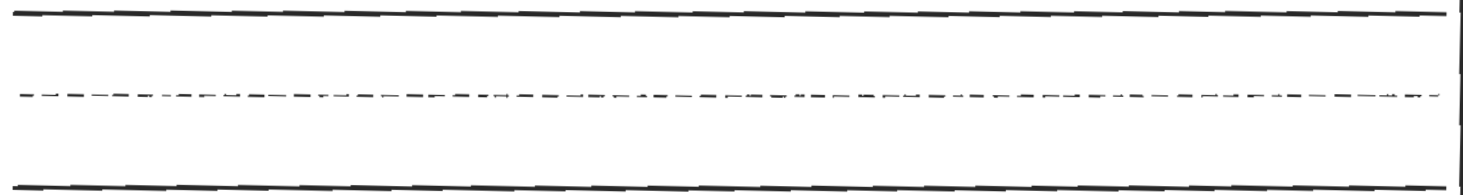
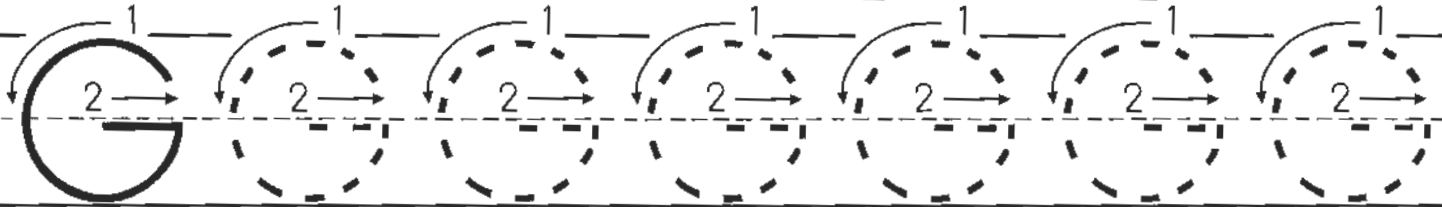
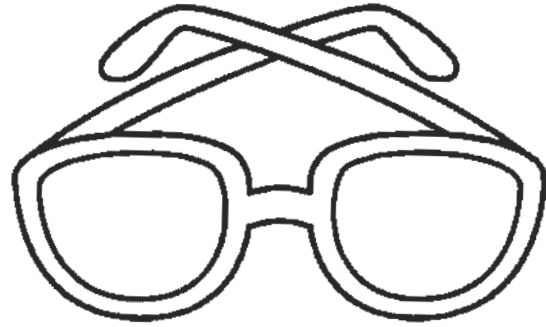
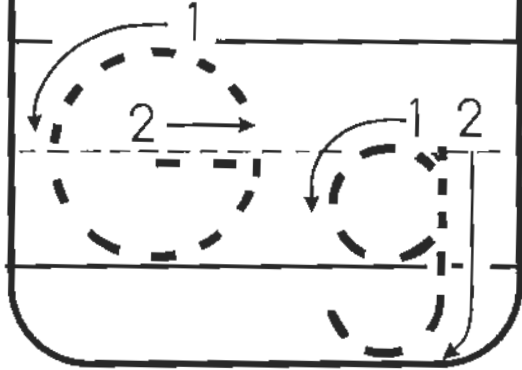

Letter

Name _____

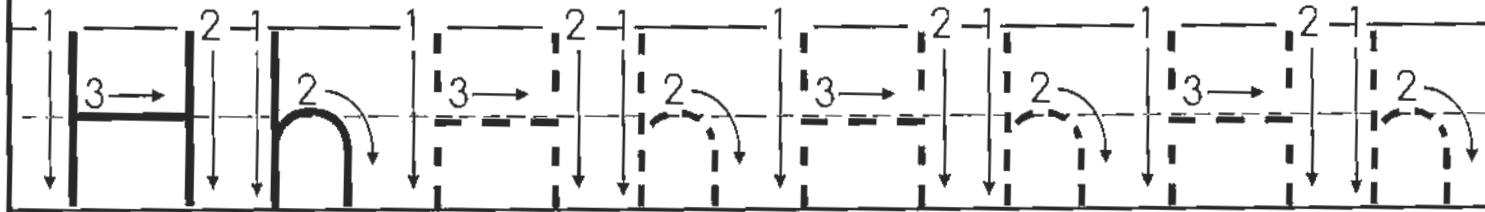
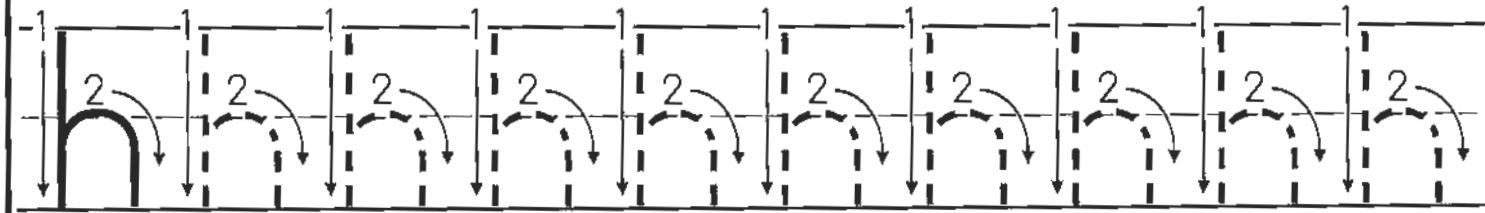
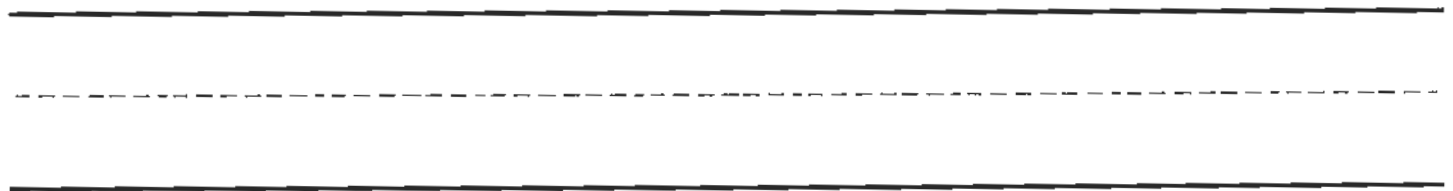
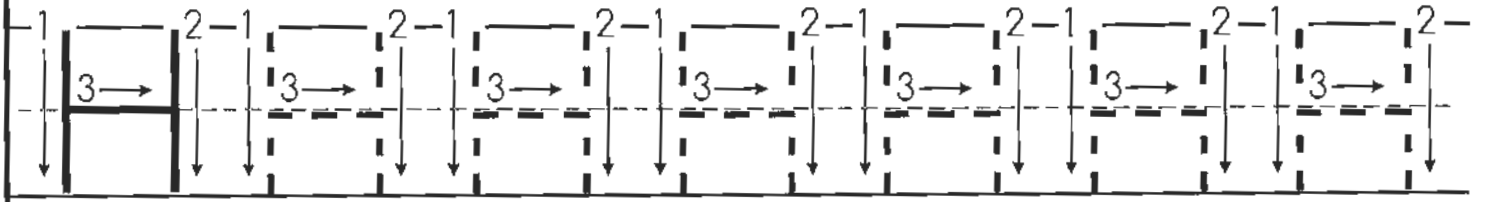
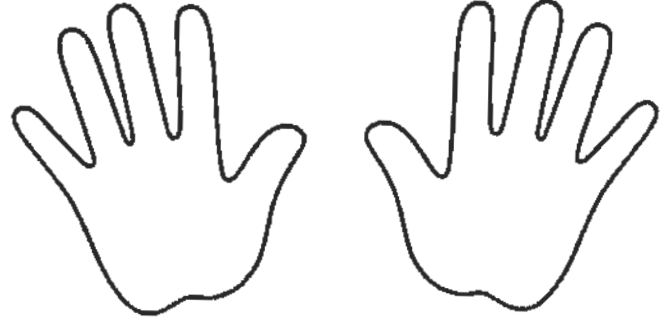
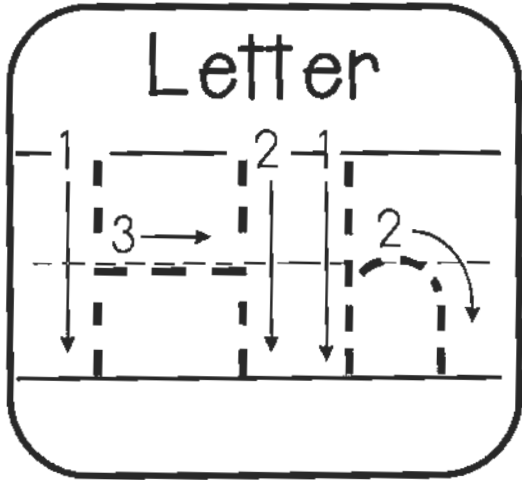

Letter

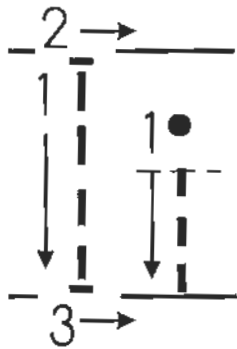

Name _____

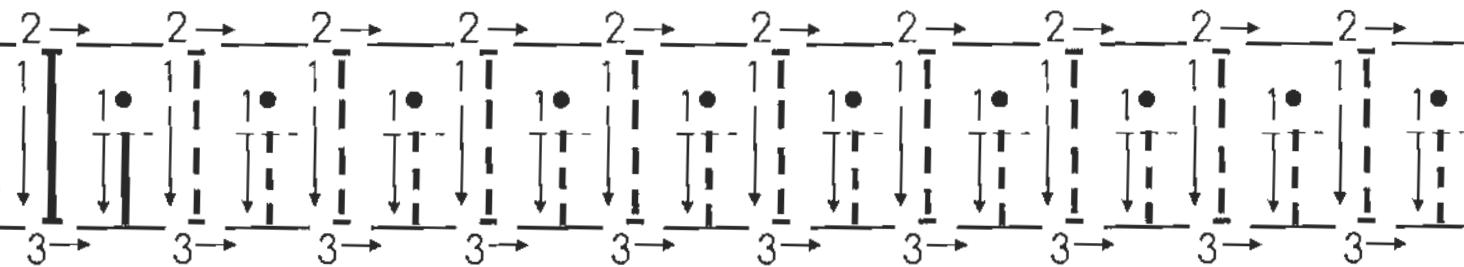
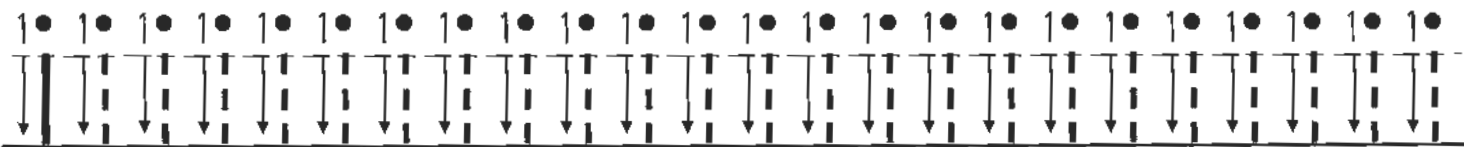
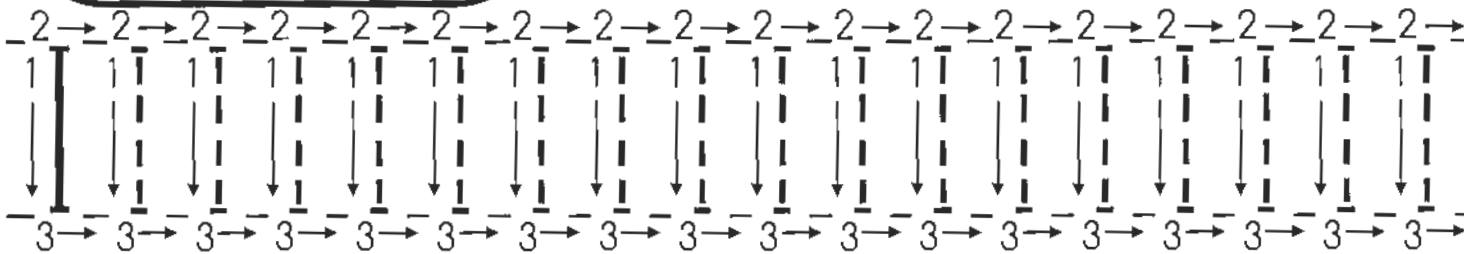
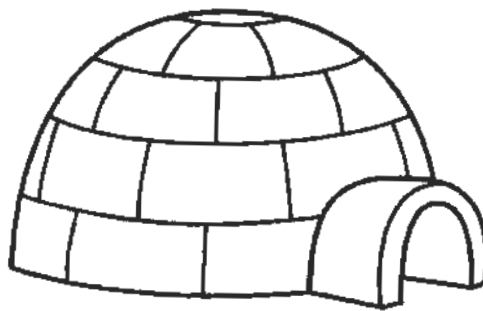

Letter

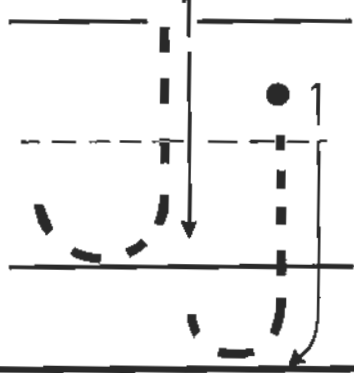

Name _____

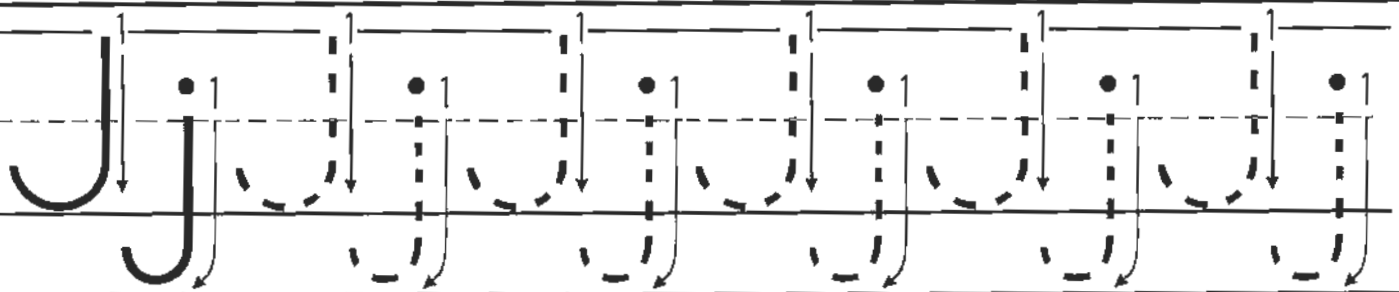
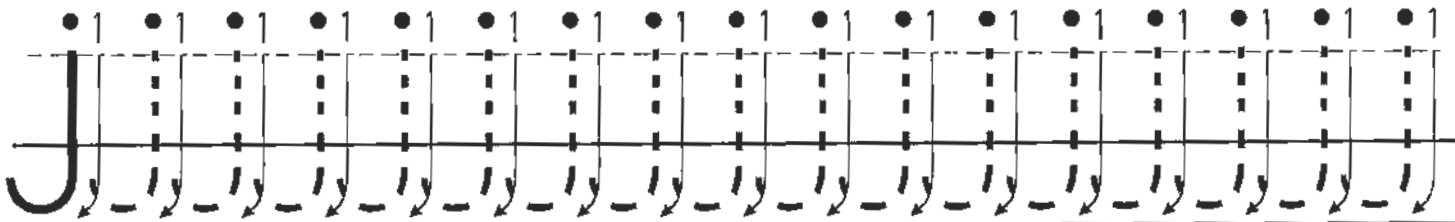
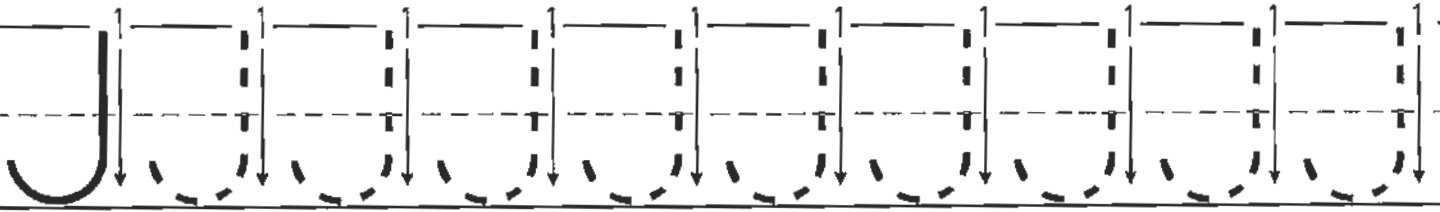

Letter

Name _____

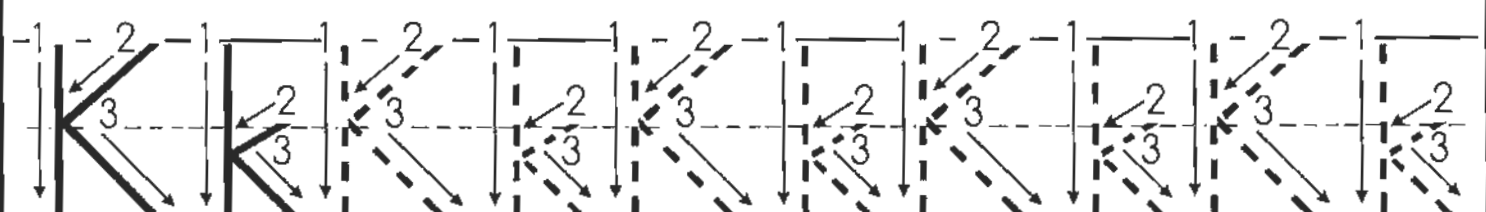
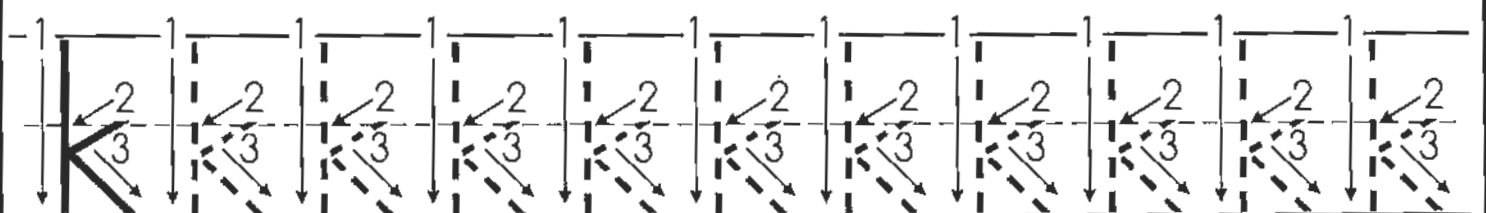
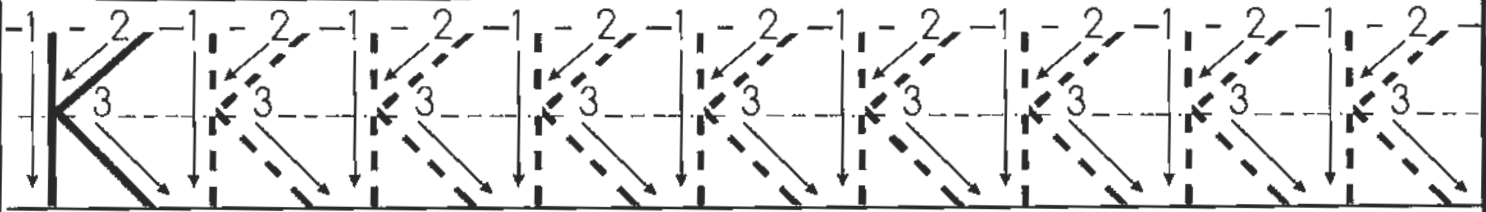
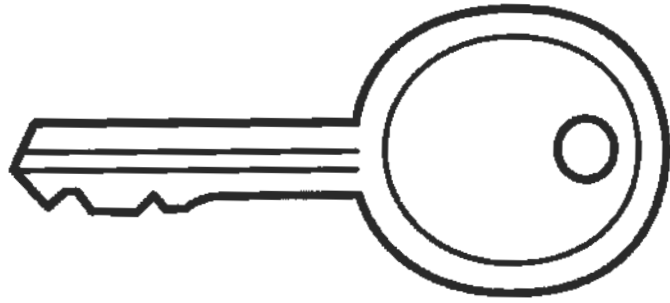
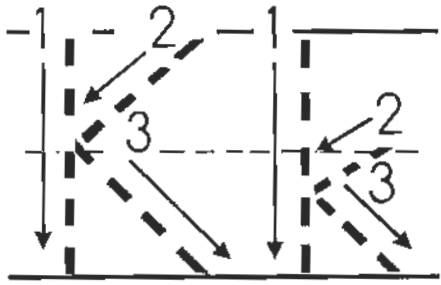

Letter

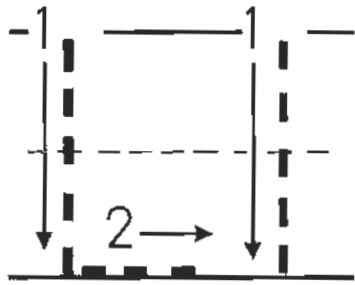

Name _____

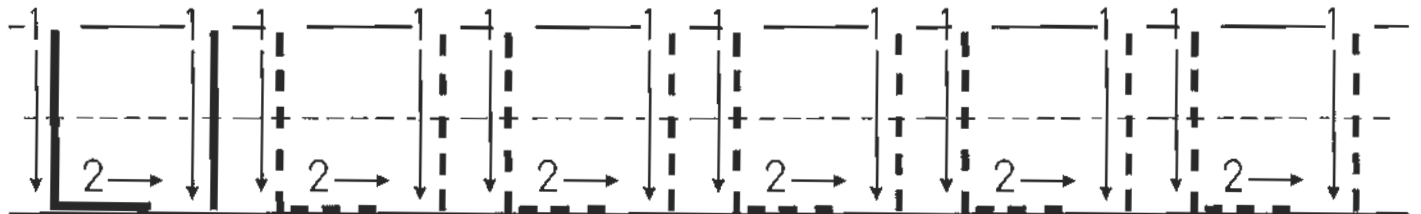
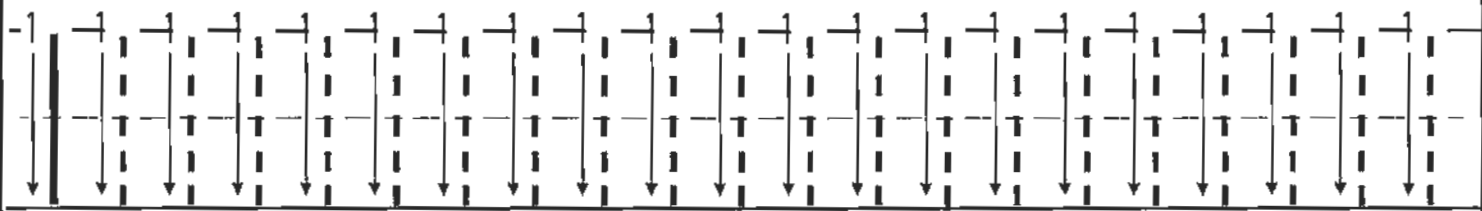
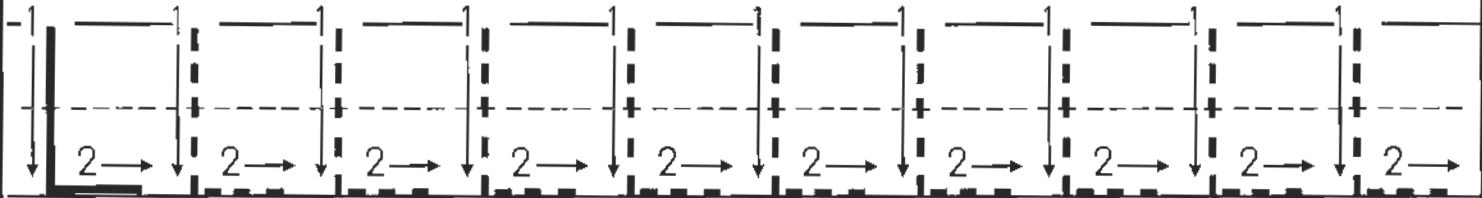
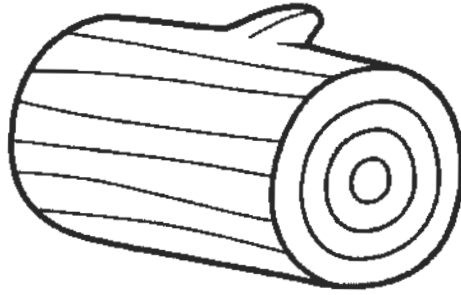

Letter

Name _____

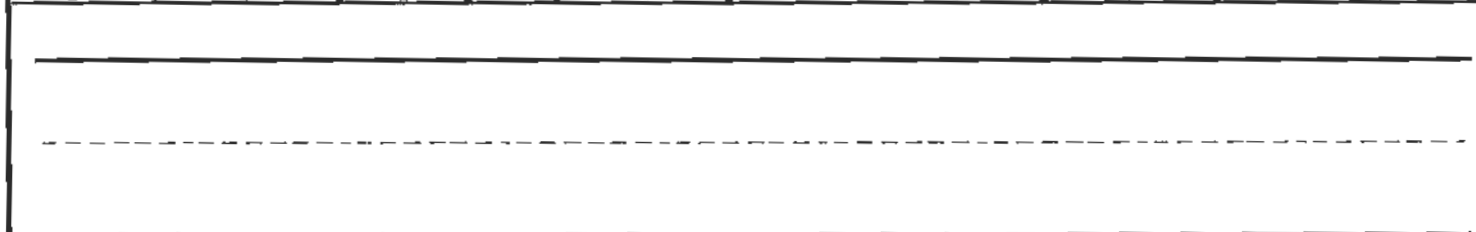
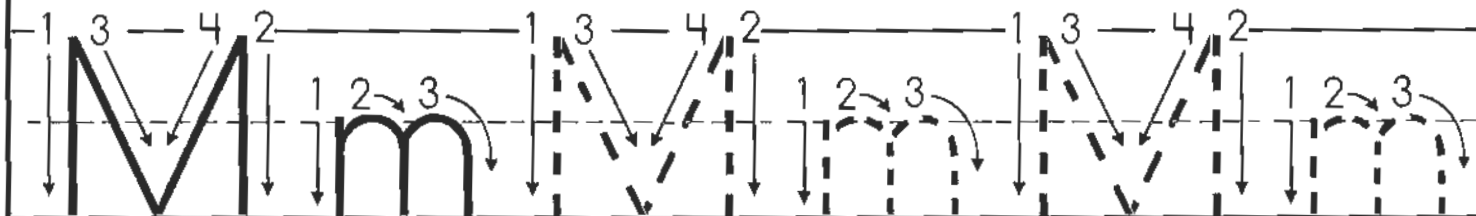
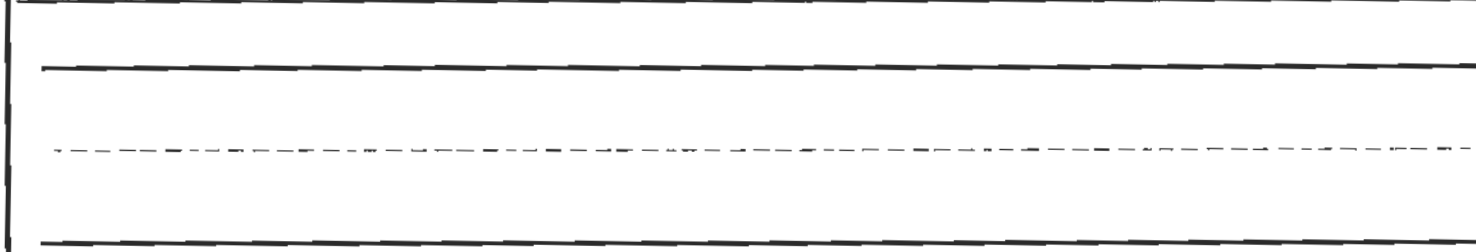
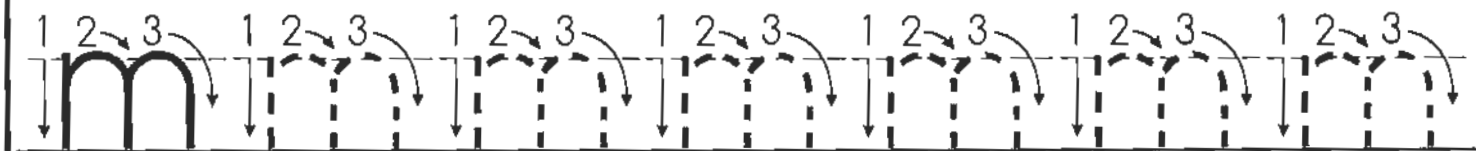
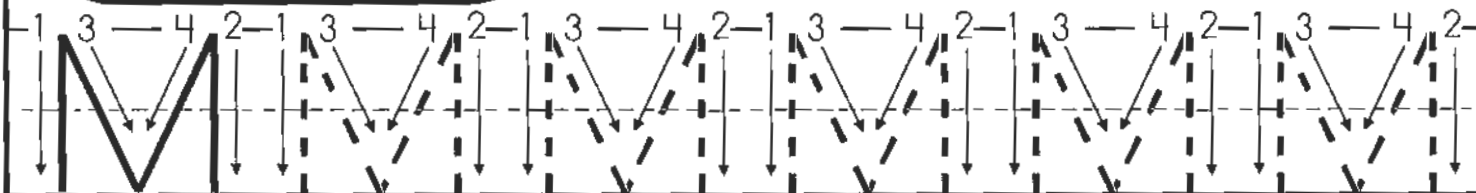
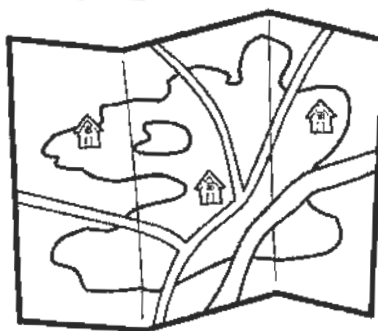
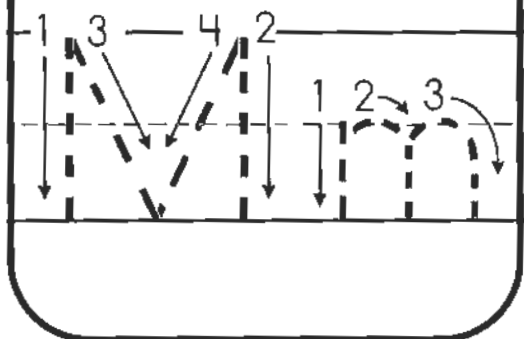

Letter

Name _____

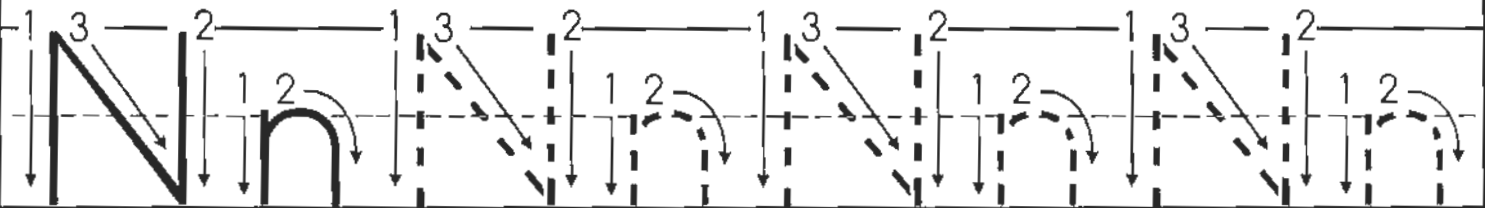
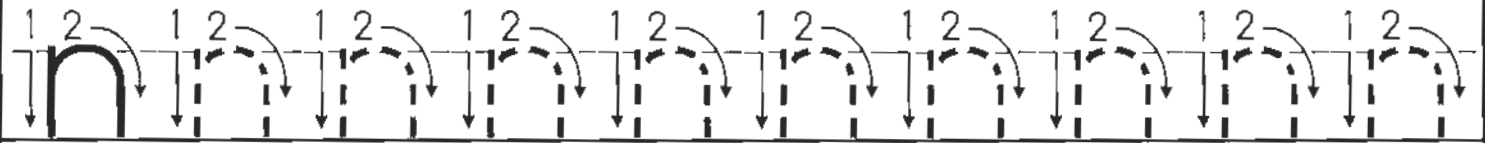
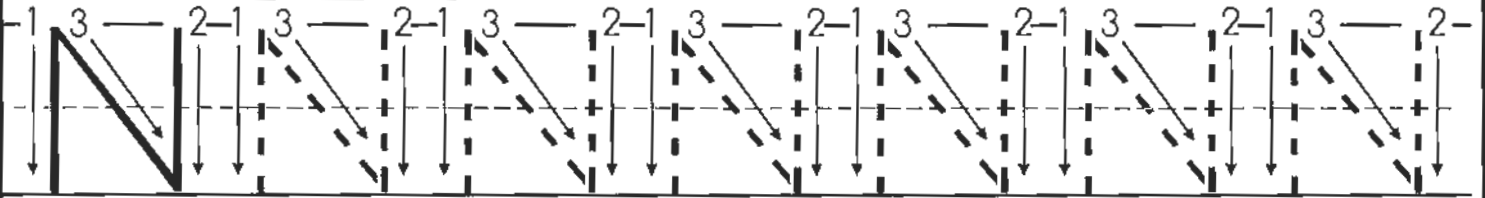
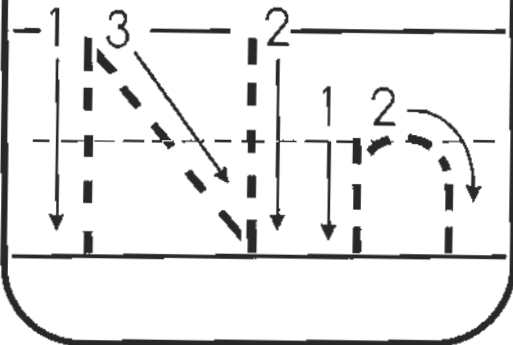

Letter

Name _____

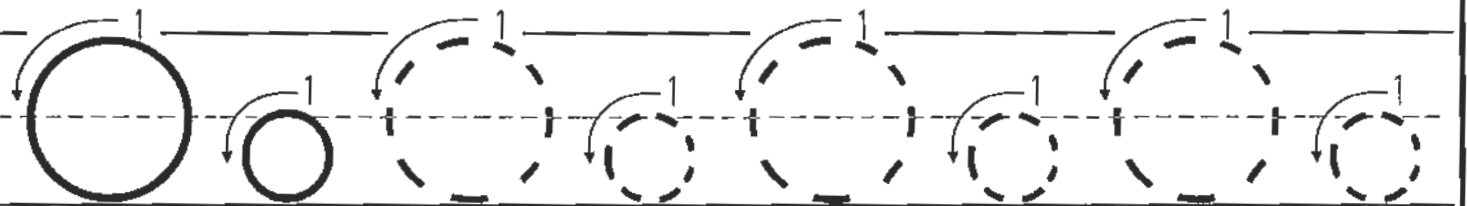
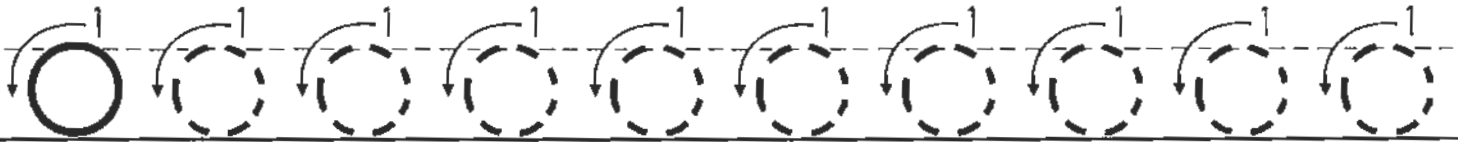
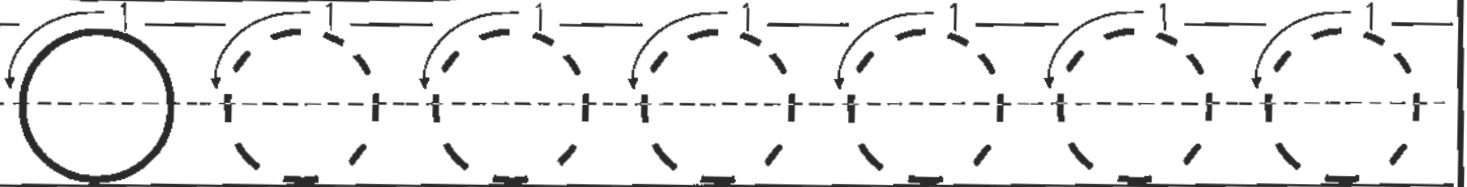
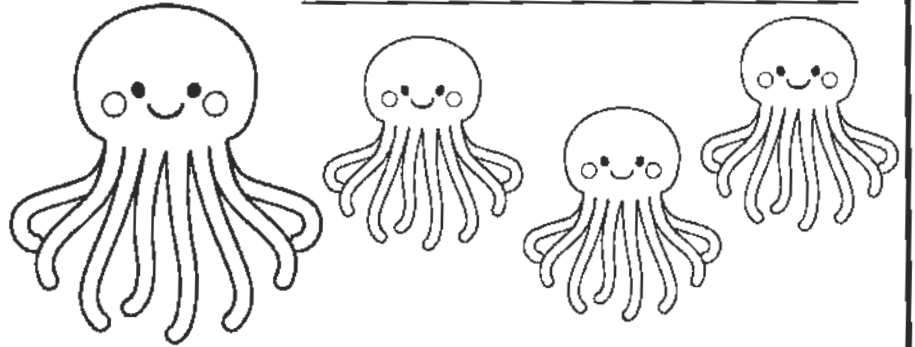
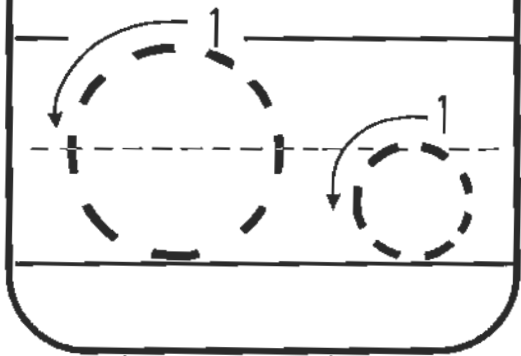

Letter

Name _____

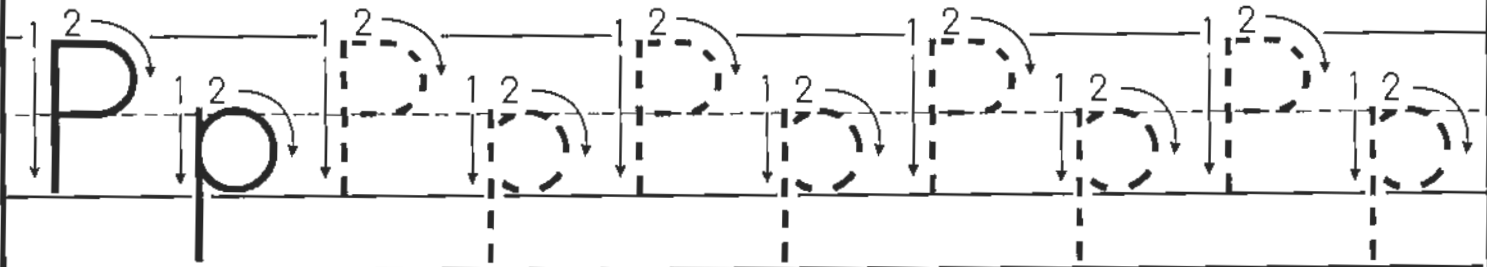
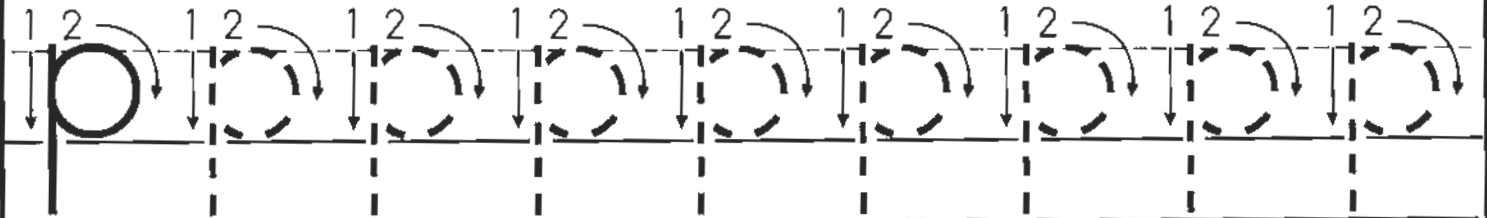
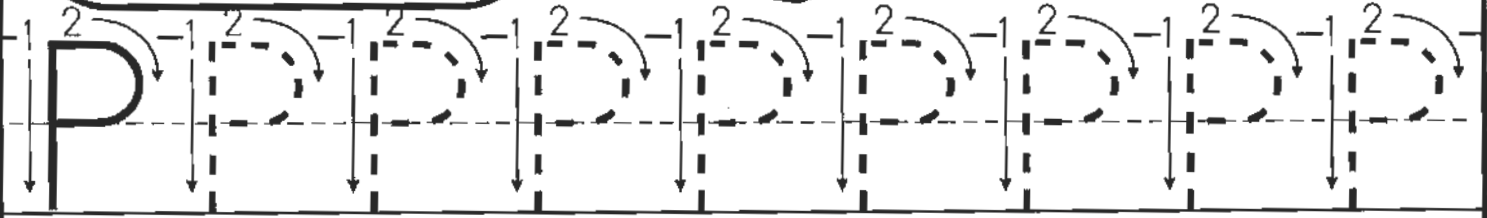
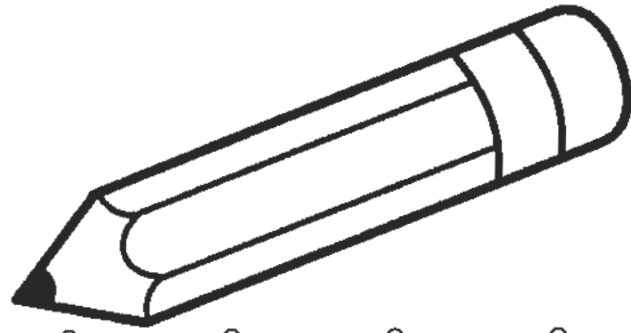
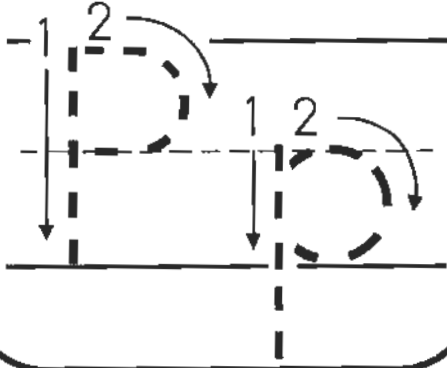

Letter

Name _____

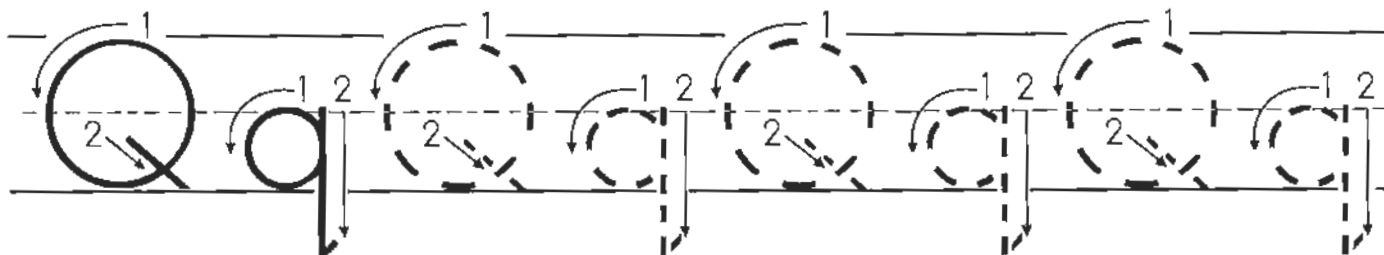
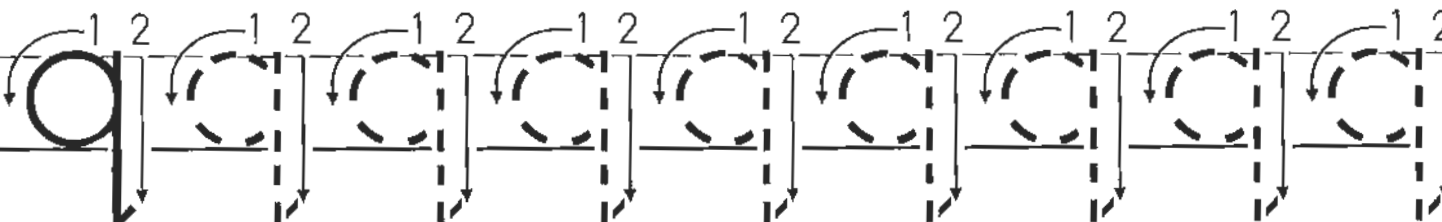
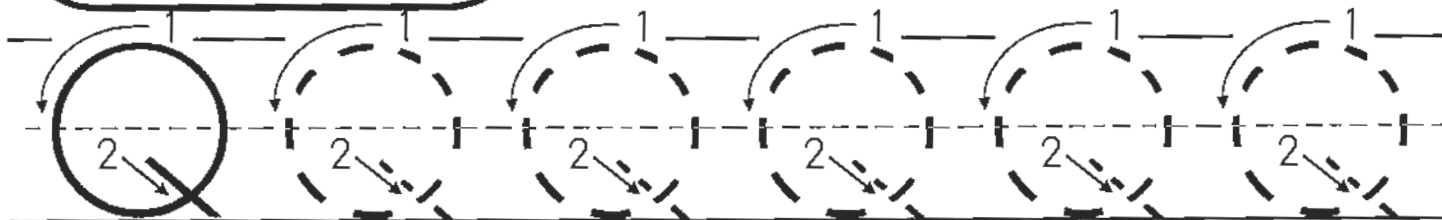
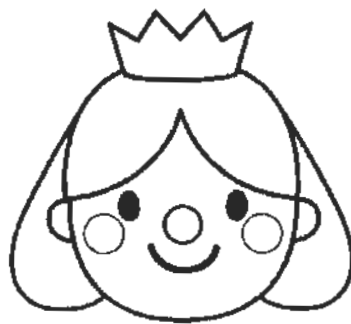
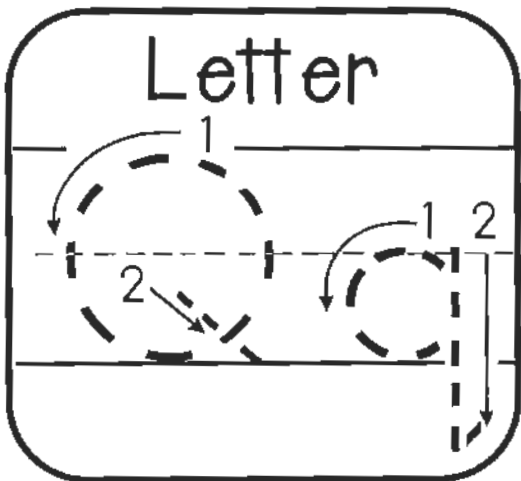

Letter

Name _____

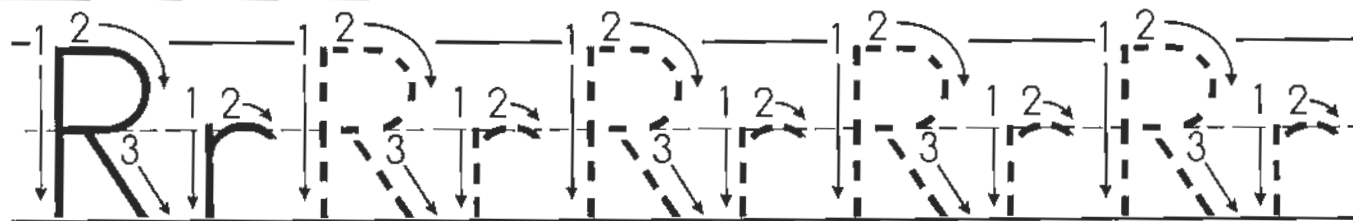
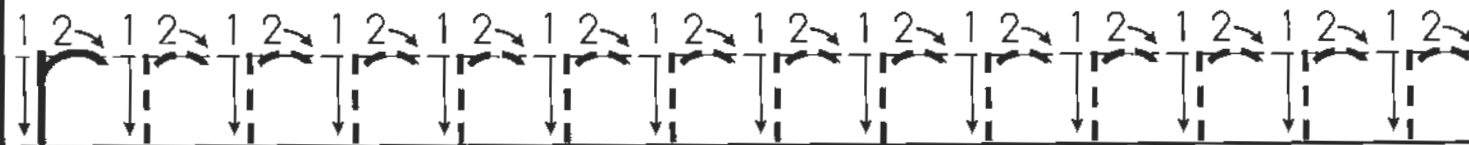
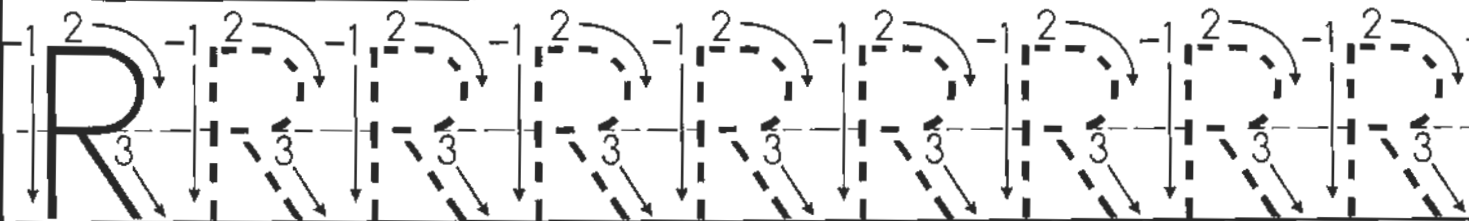
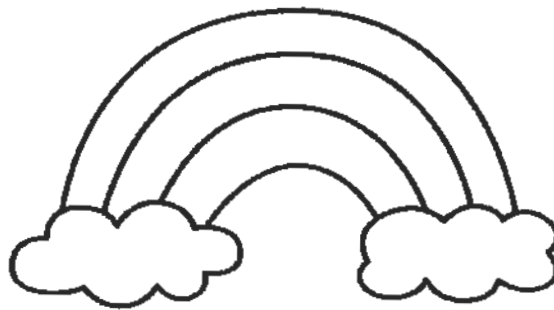
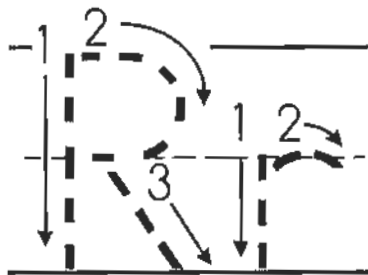

Letter

Name _____

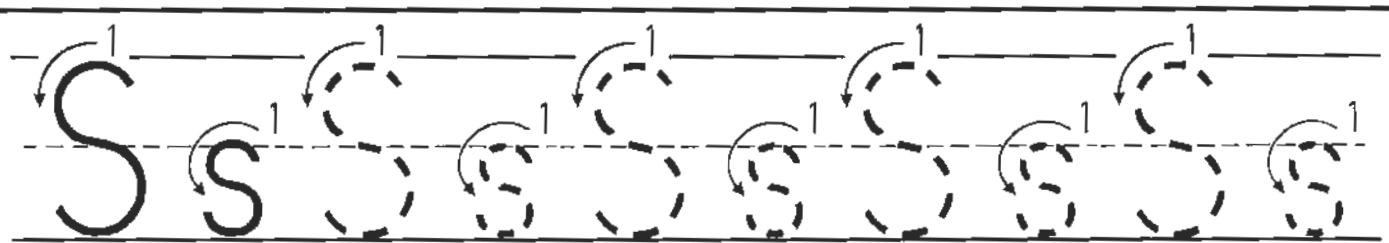
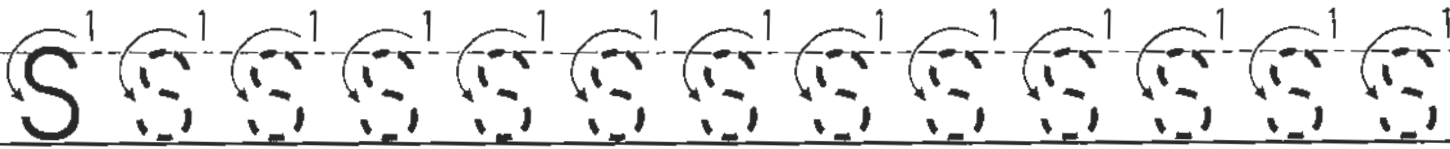
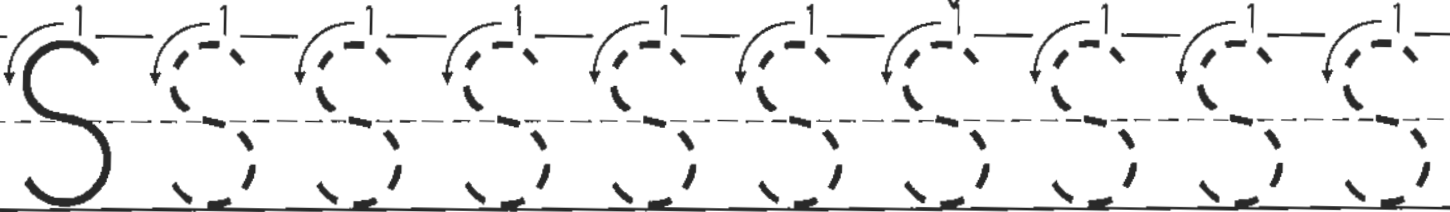
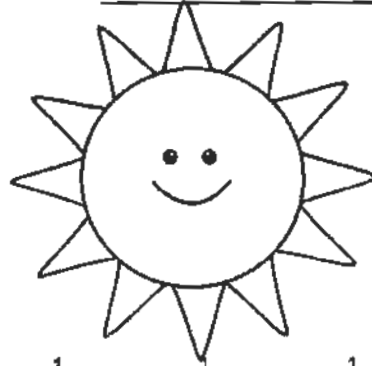
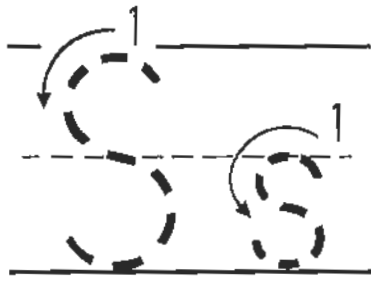

Letter

Name _____

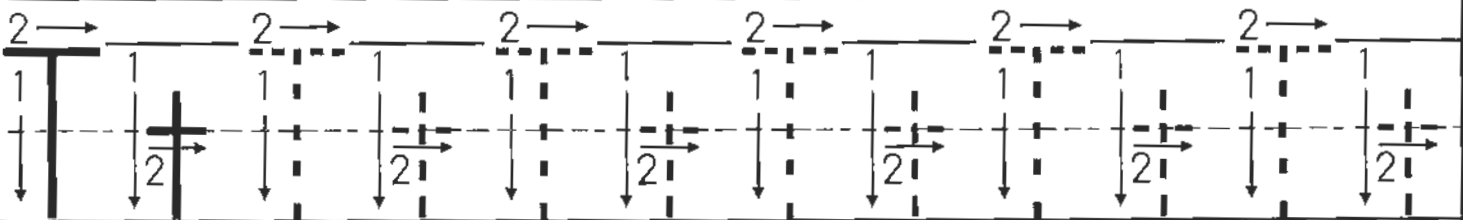
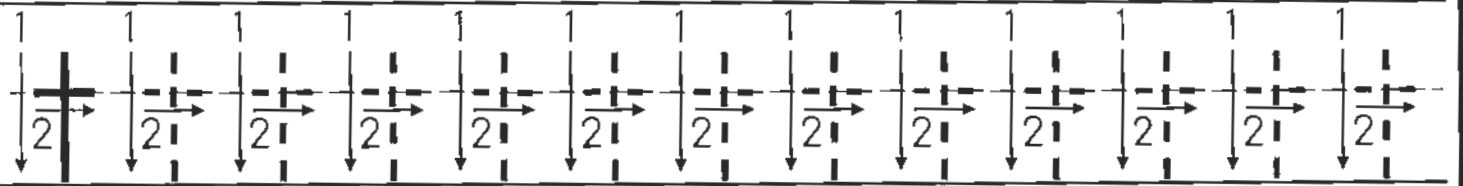
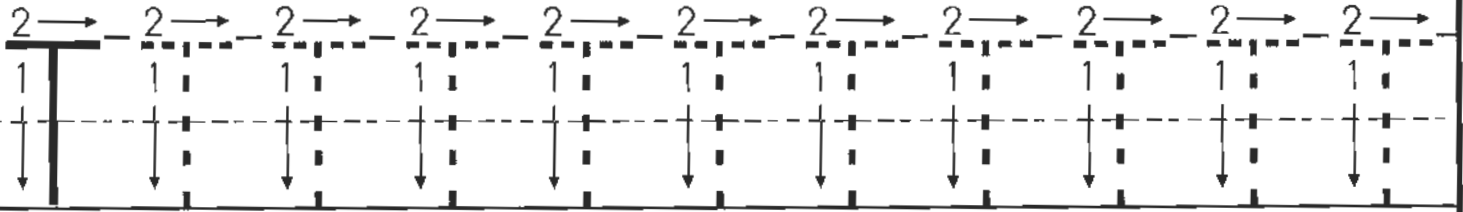
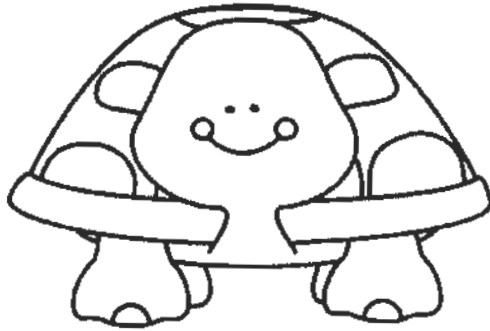
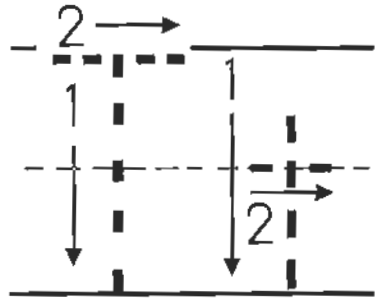

Letter

Name _____

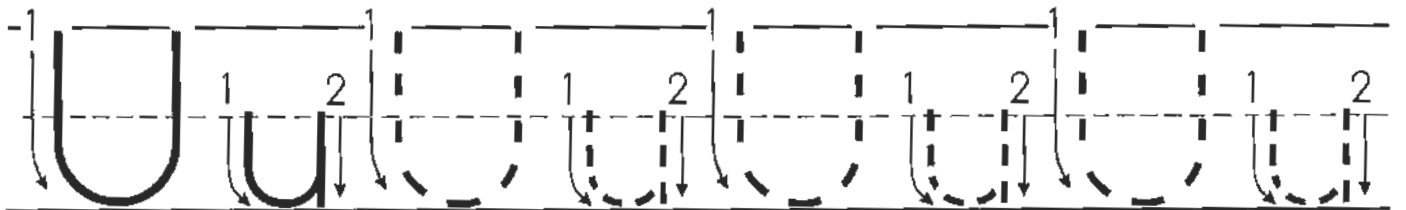
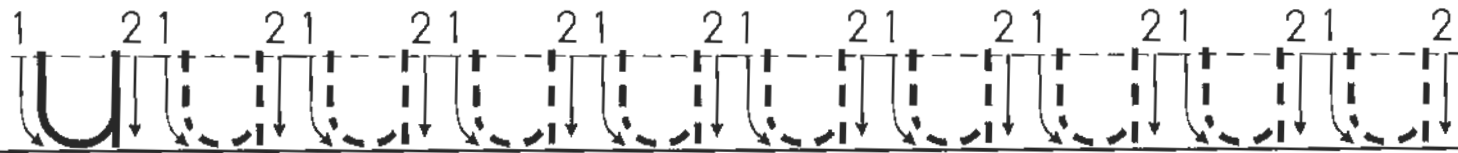
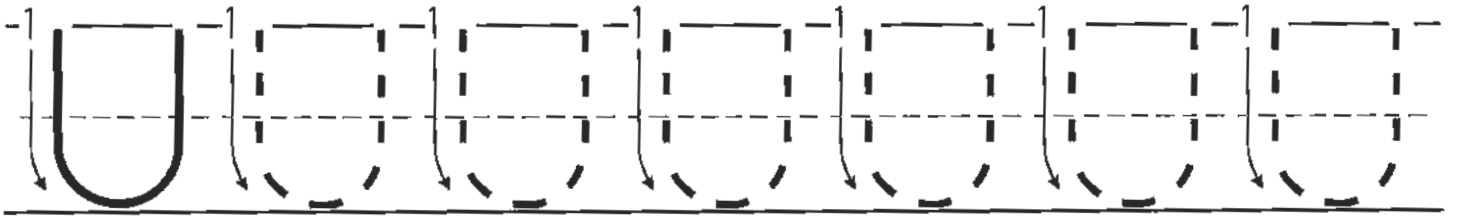
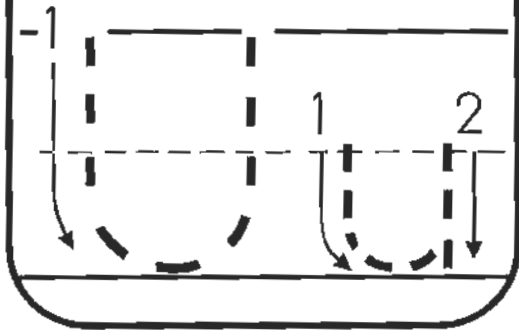

Letter

Name _____

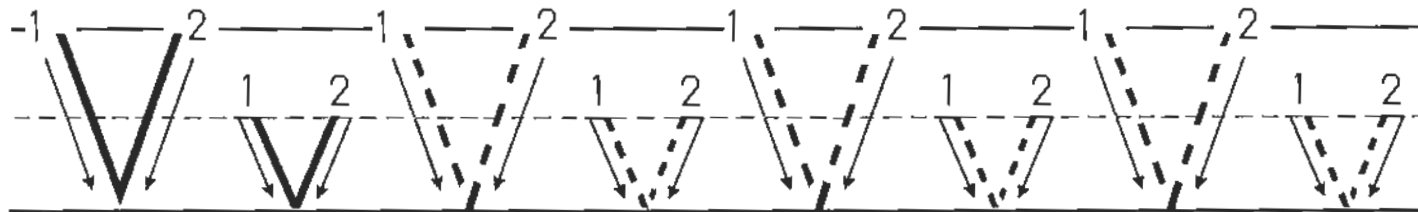
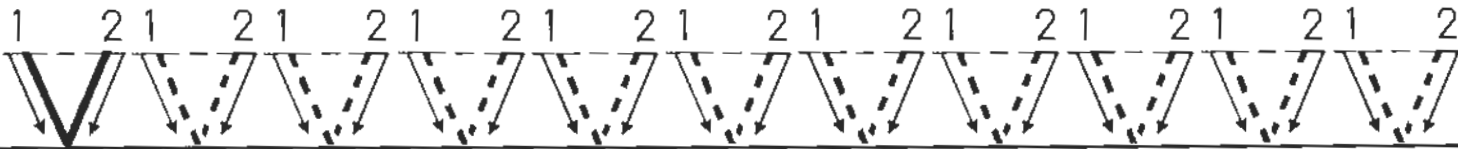
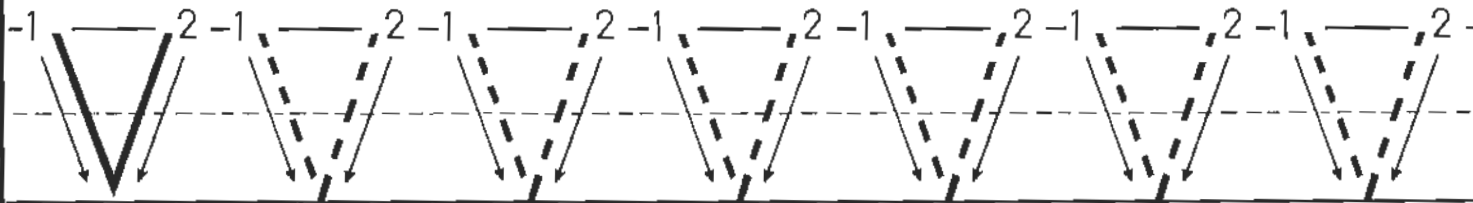
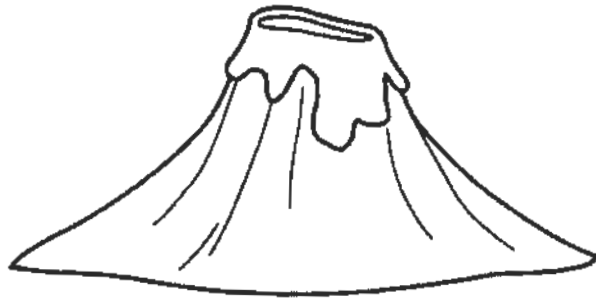
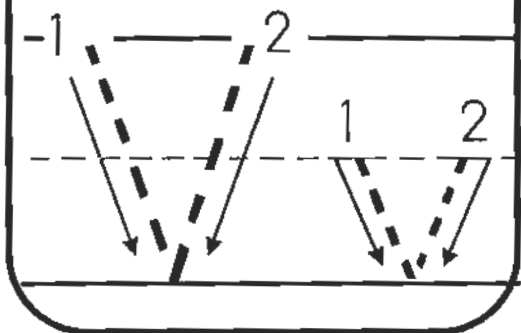

Letter

Name _____

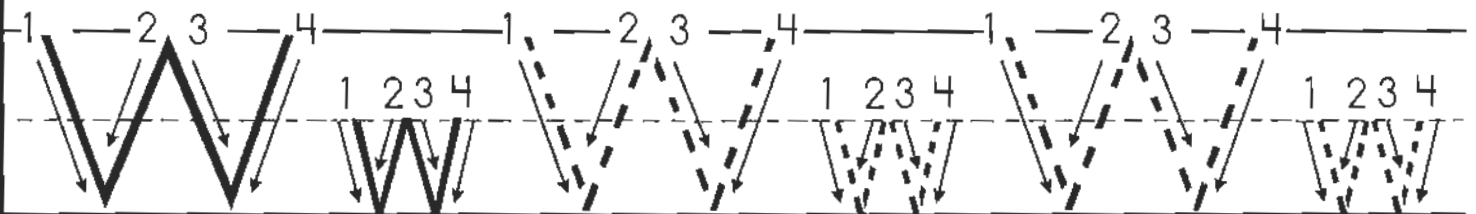
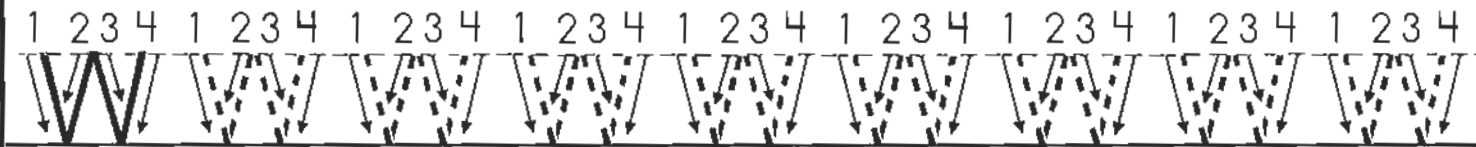
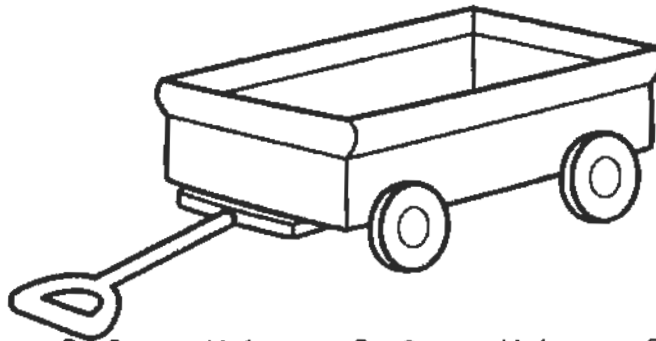
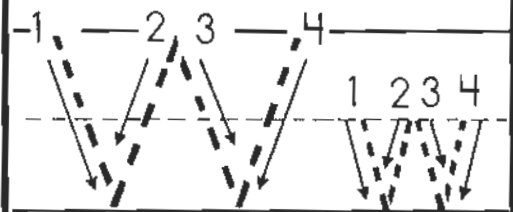

Letter

Name _____

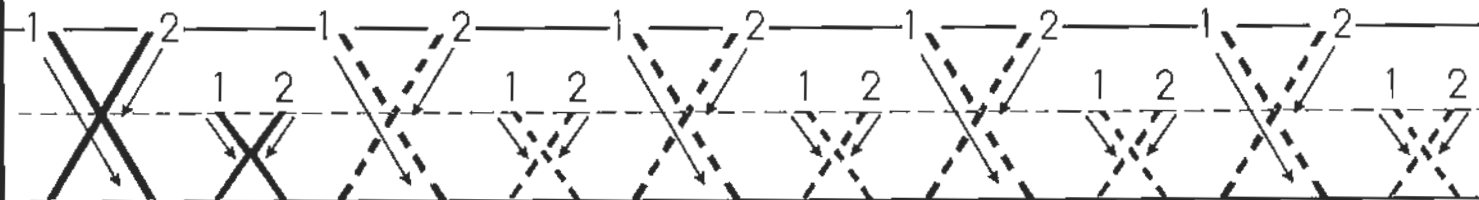
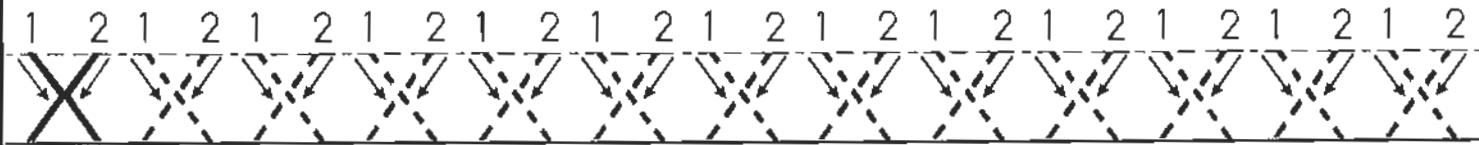
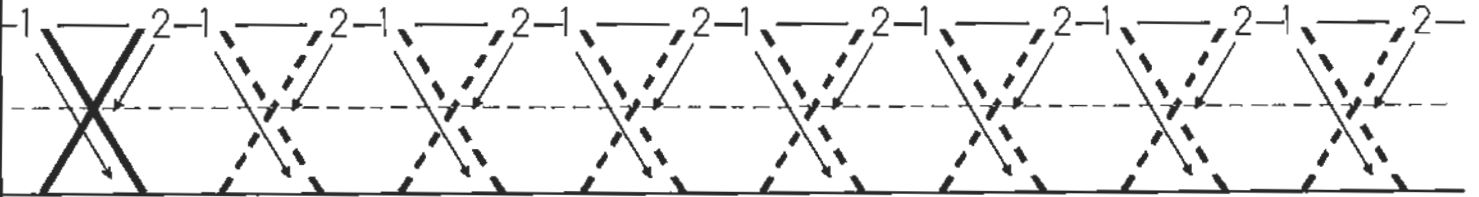
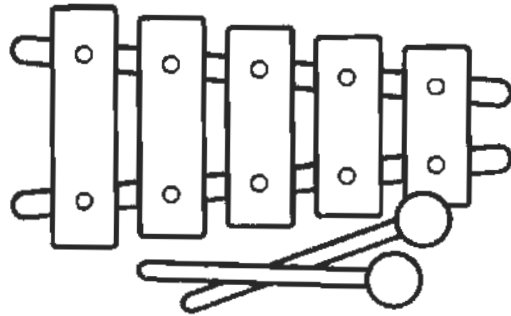
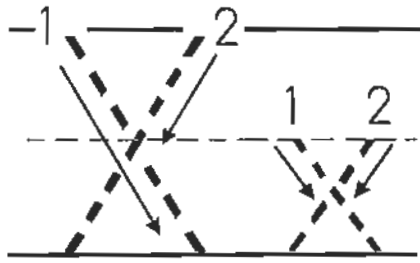

Letter

Name _____

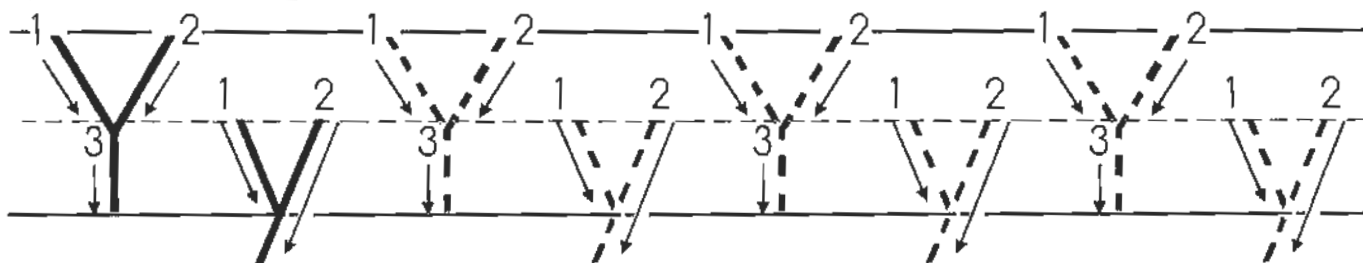
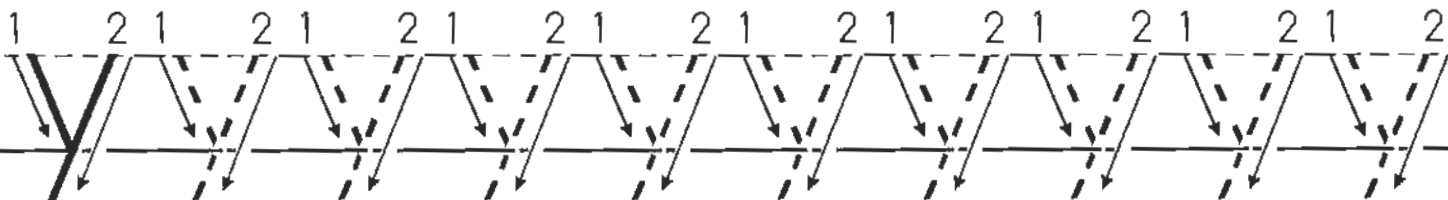
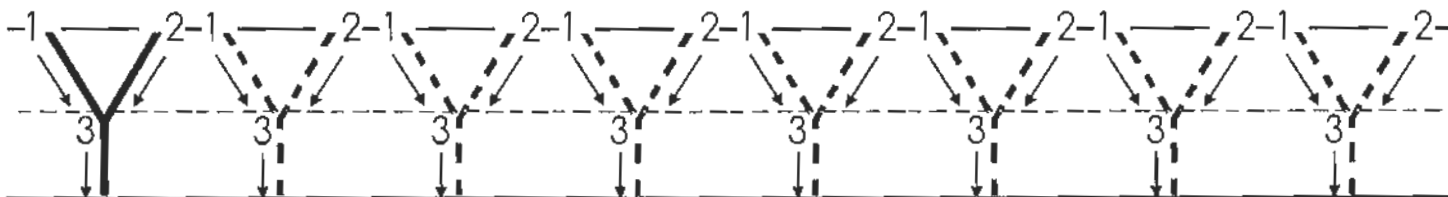
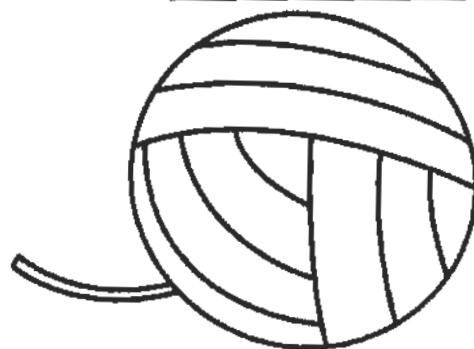
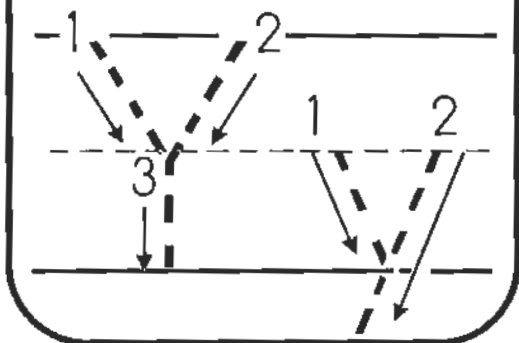

Letter

Name _____

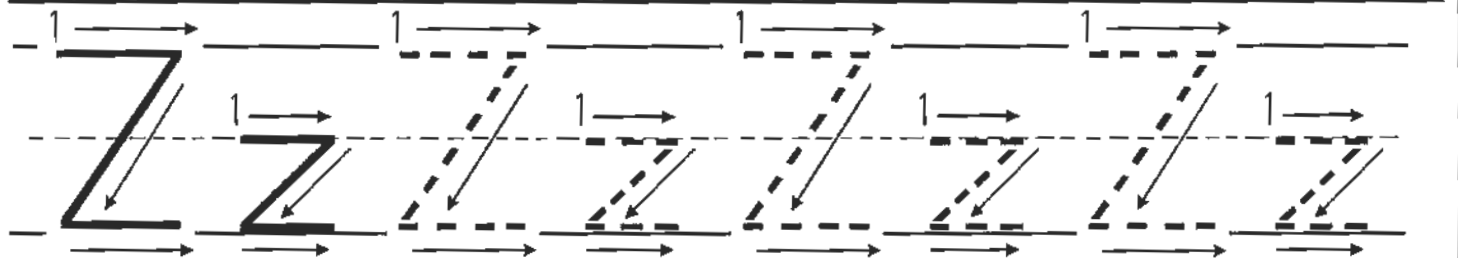
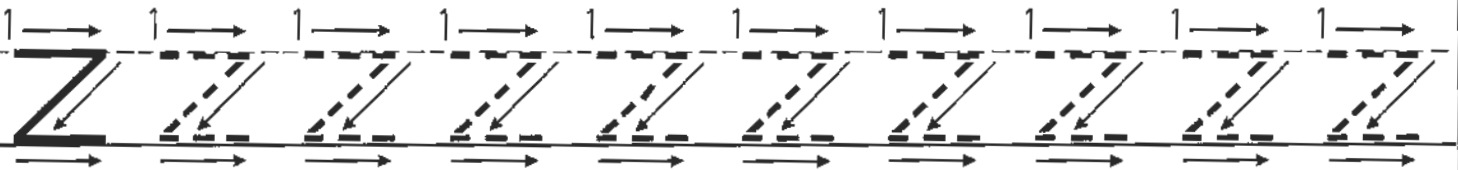
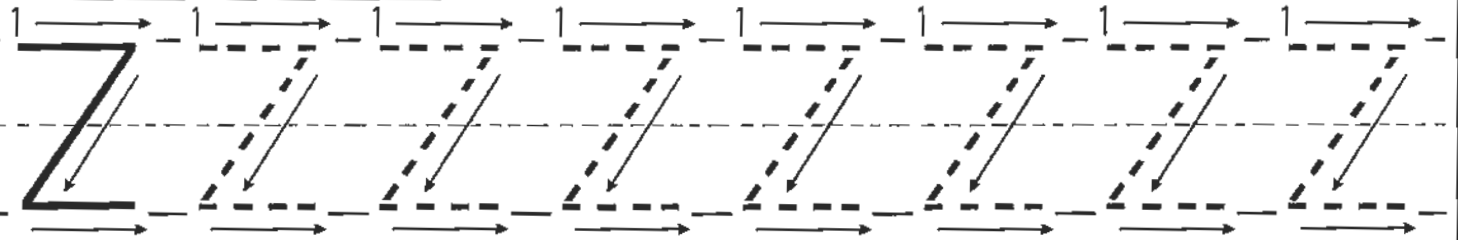
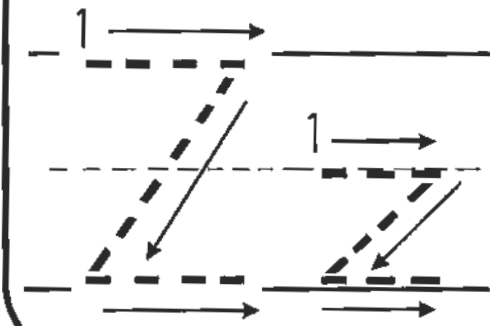

Letter Aa Activity Sheet

Trace the letter

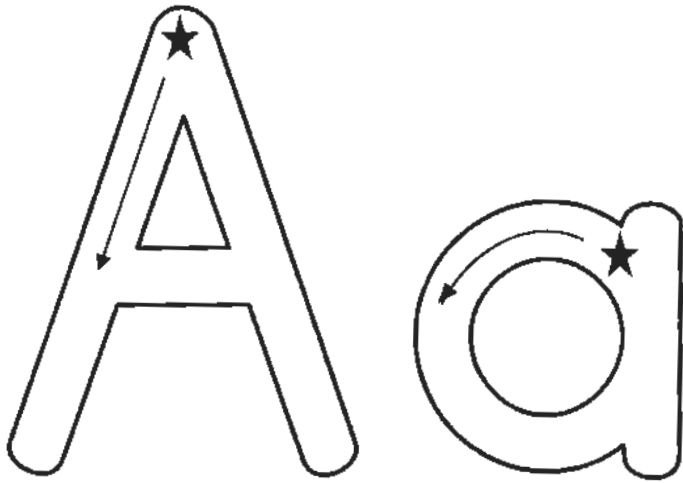

Find the letter



Color the pictures

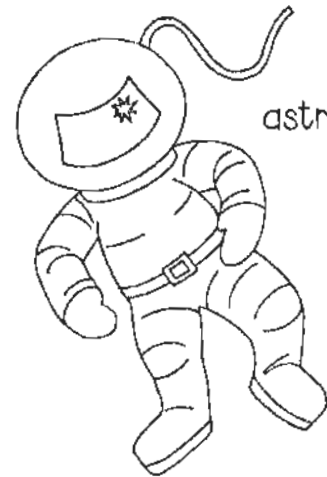
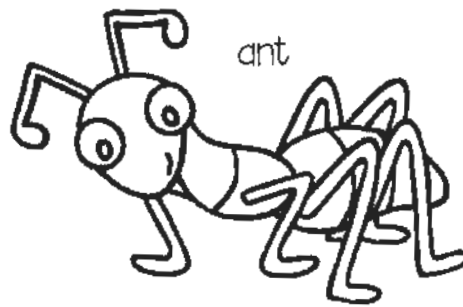
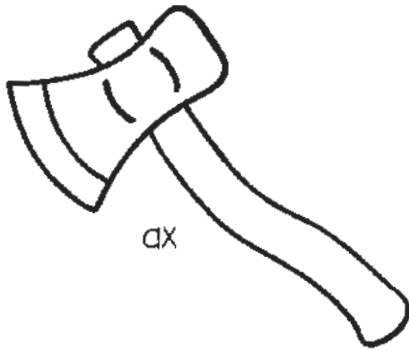

alligator



apple



alphabet

Make a pattern

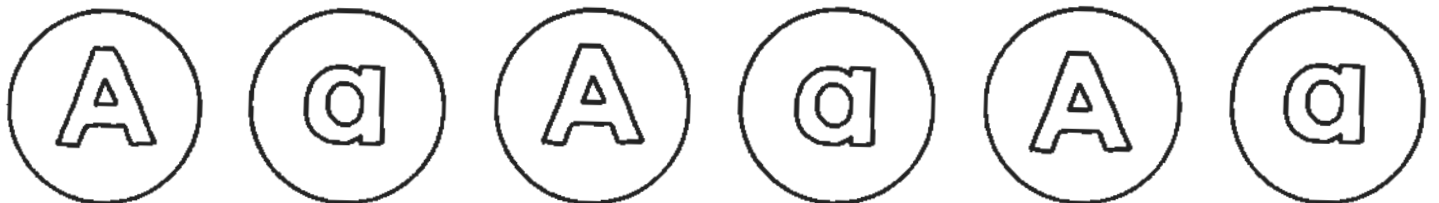

Letter Bb Activity Sheet

Trace the letter

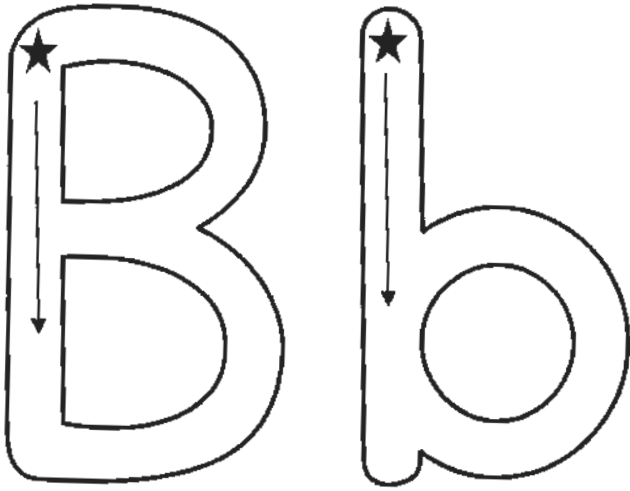

Find the letter

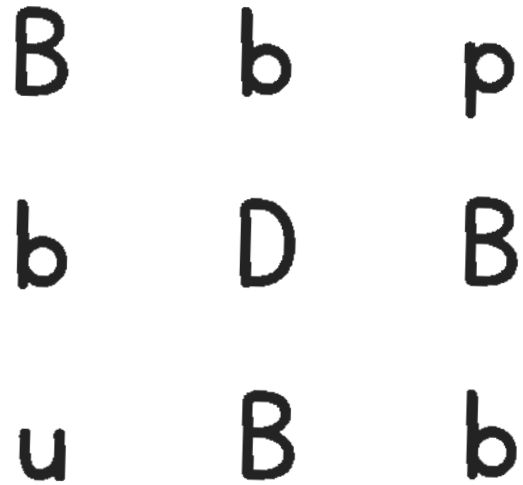

Color the pictures

ball

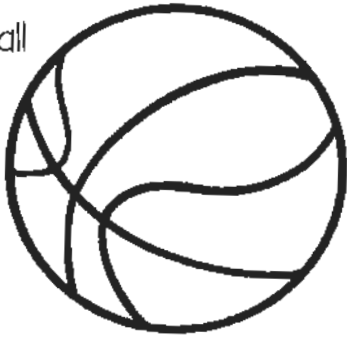

bird

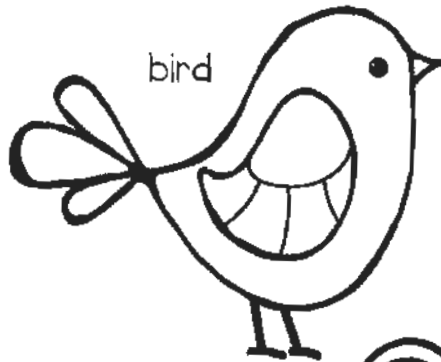

book

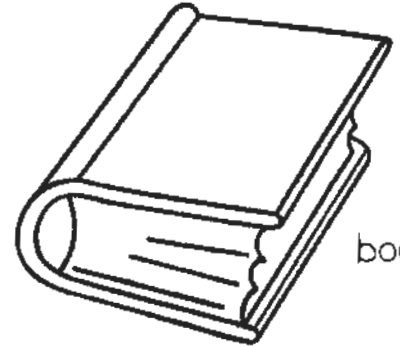

boat

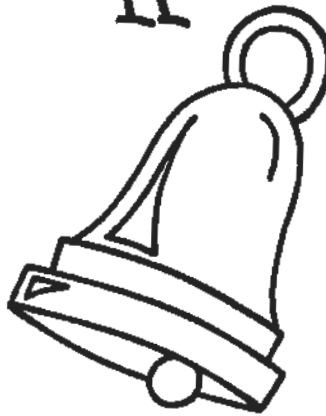

bell

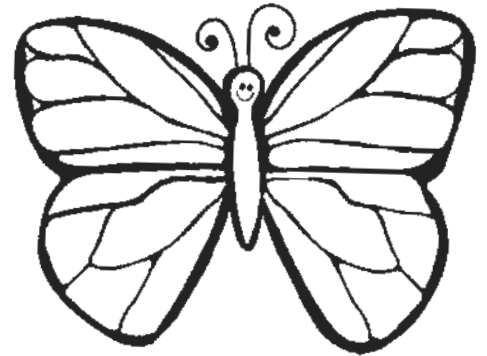

butterfly

Make a pattern

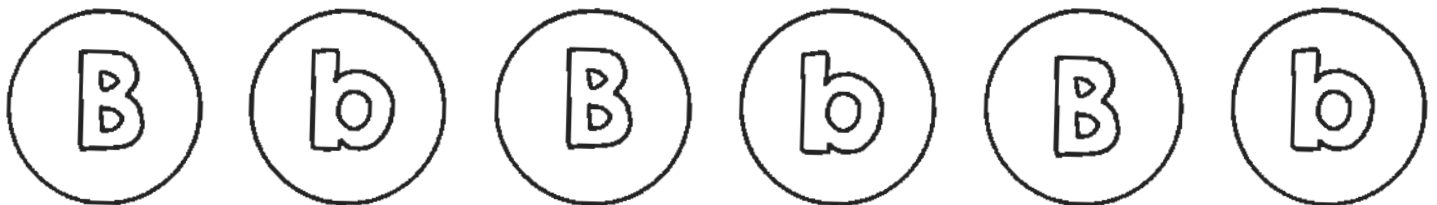

Letter Cc Activity Sheet

Trace the letter

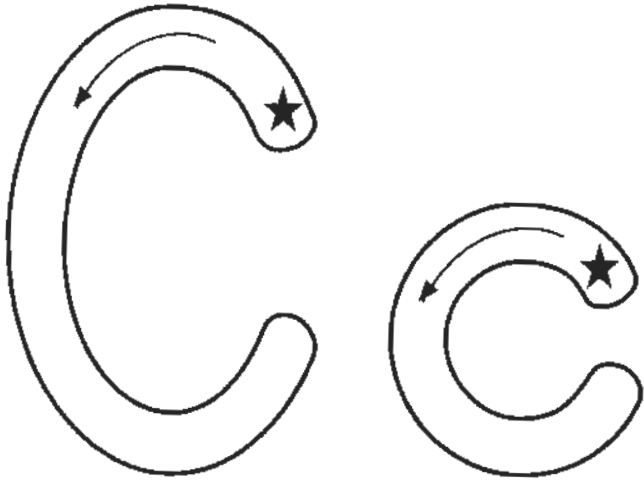

Find the letter

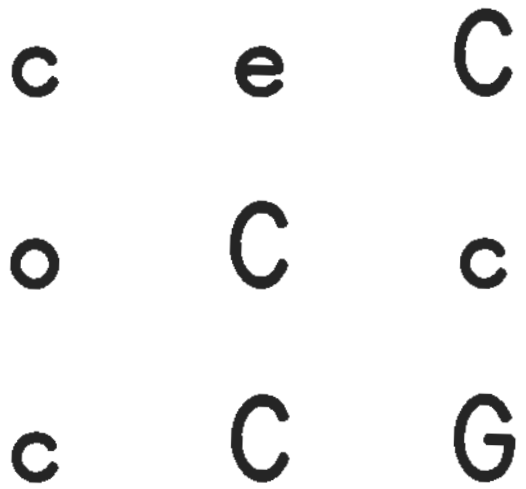

Color the pictures

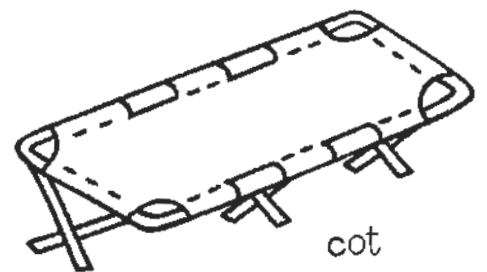
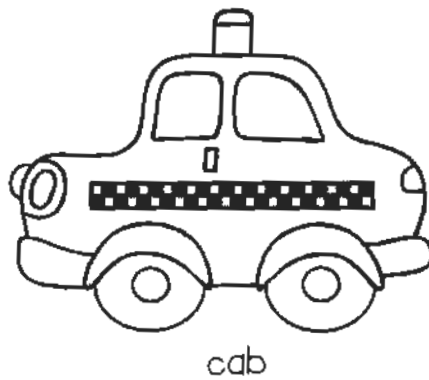
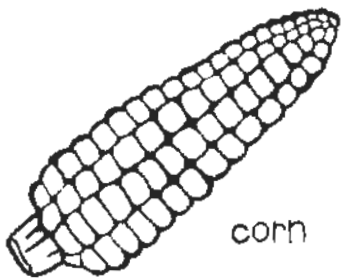
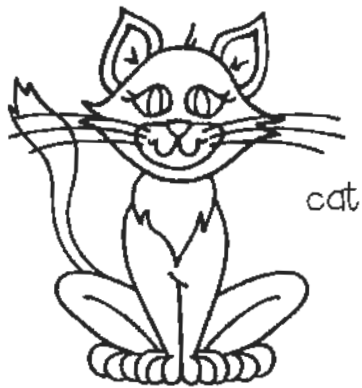

Make a pattern

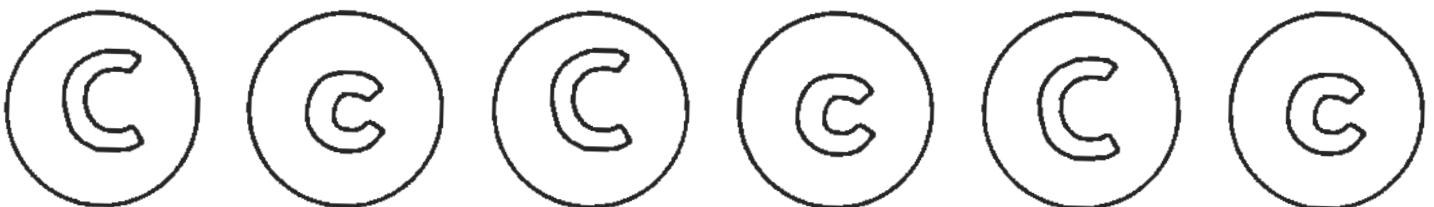

Letter Dd Activity Sheet

Trace the letter

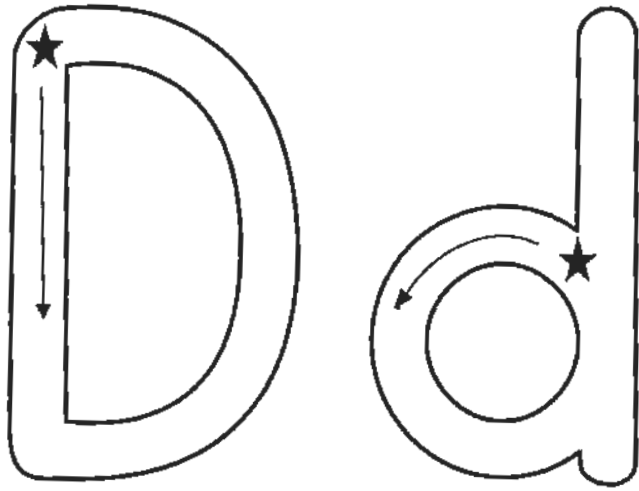

Find the letter

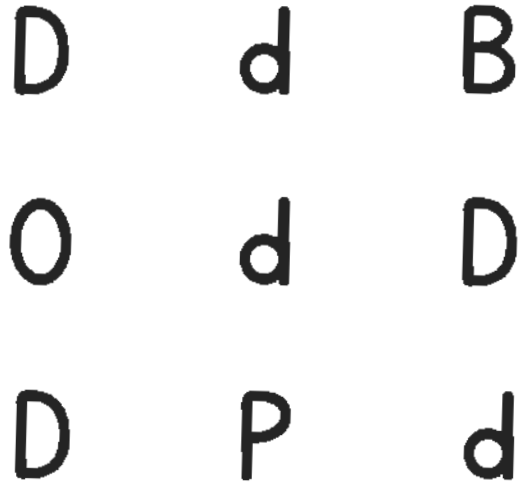

Color the pictures

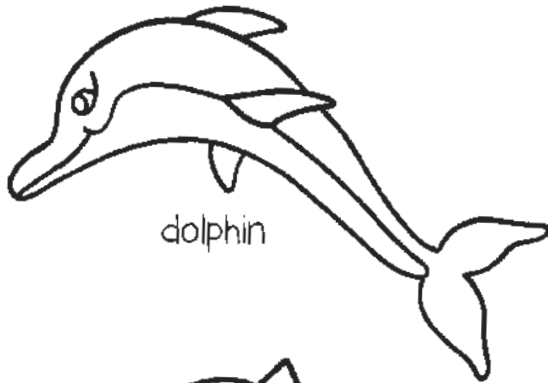

dolphin



diamond

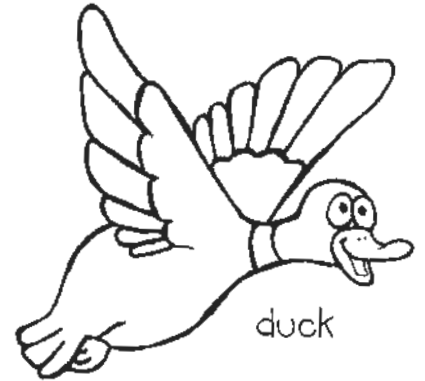

duck



doll

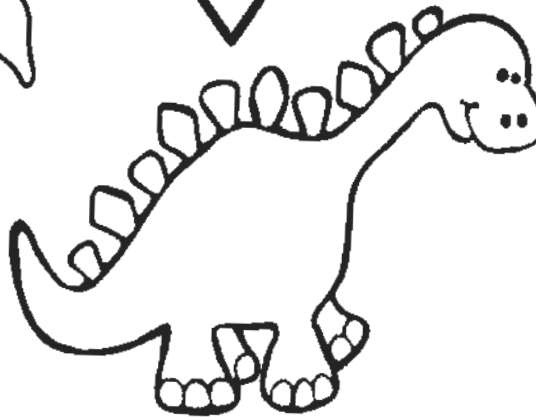

dinosaur

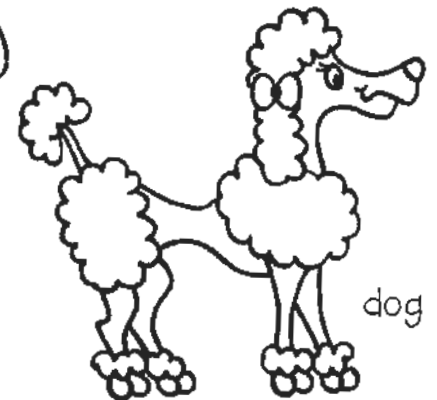

dog

Make a pattern

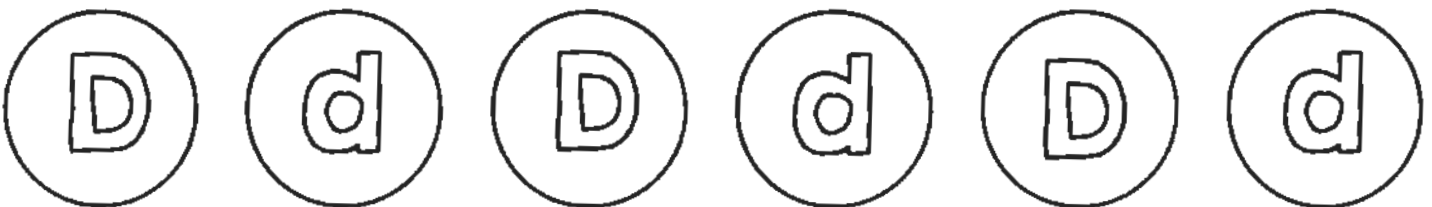

Letter Ee Activity Sheet

Trace the letter

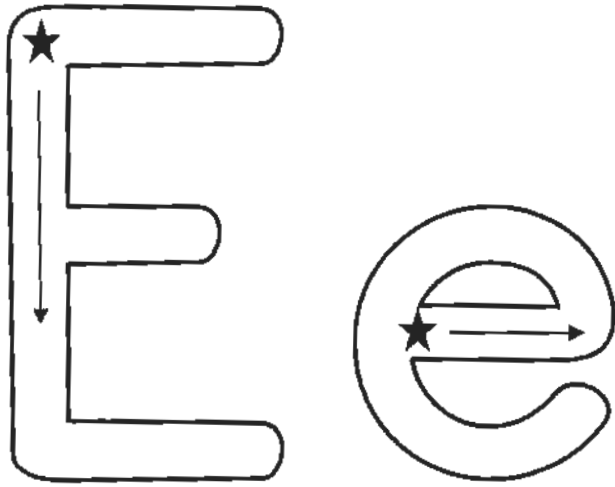

Find the letter

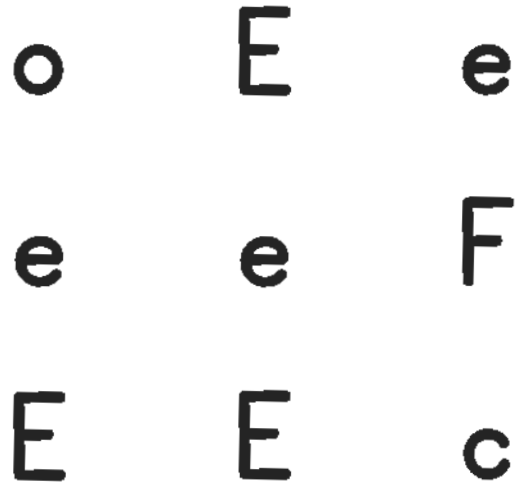

Color the pictures



elephant

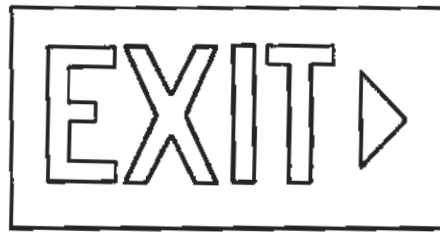

exit



evergreens

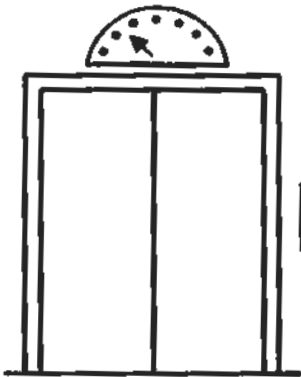

elevator

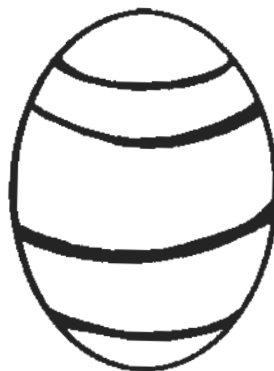

egg

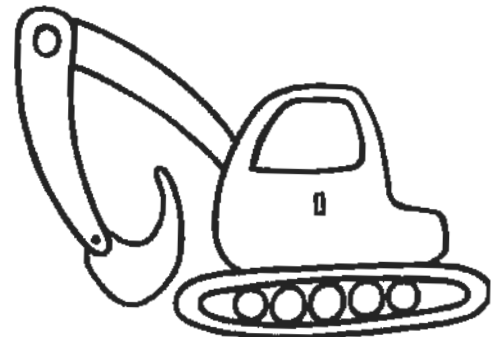

excavator

Make a pattern

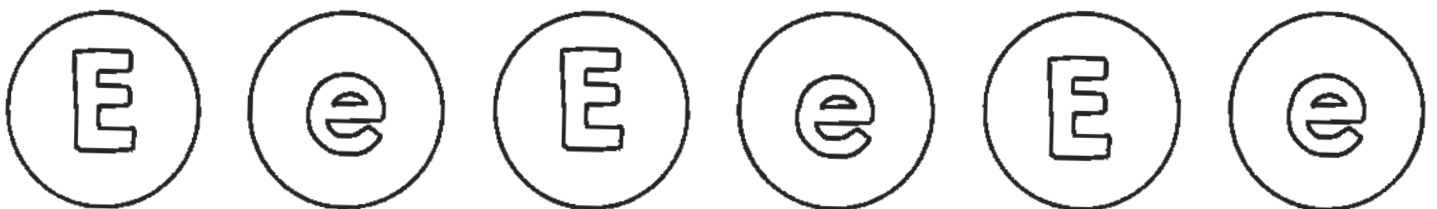

Letter Ff Activity Sheet

Trace the letter

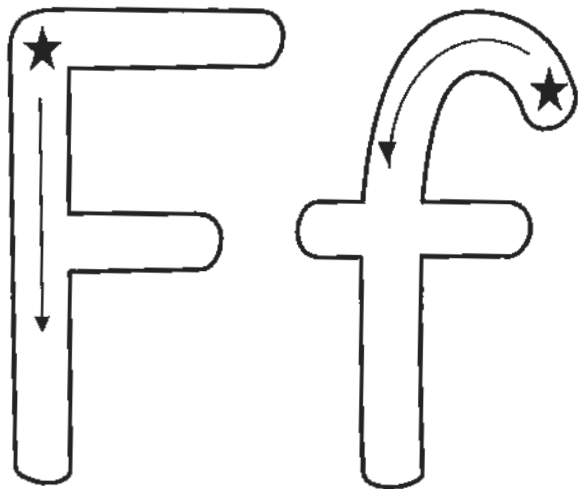

Find the letter

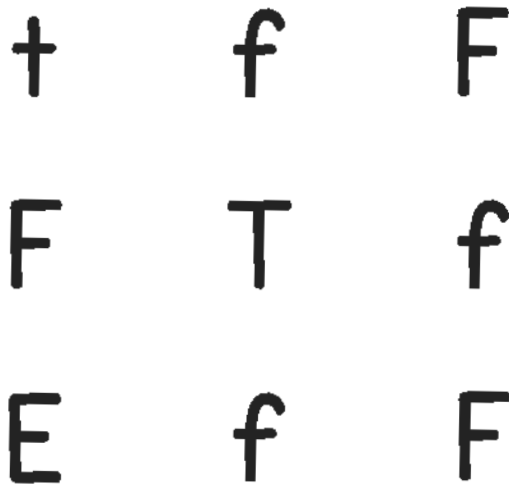

Color the pictures



fox

football

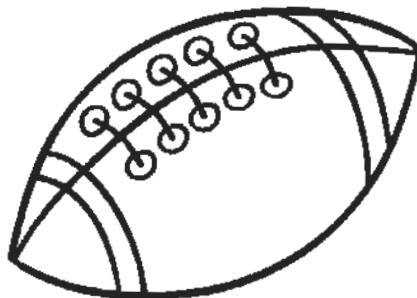

five

forklift

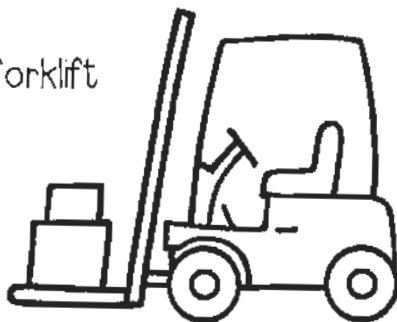

fire



fish

Make a pattern

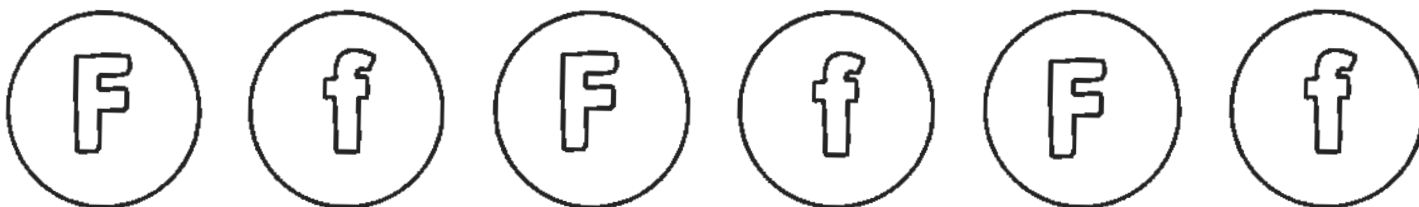

Letter Gg Activity Sheet

Trace the letter

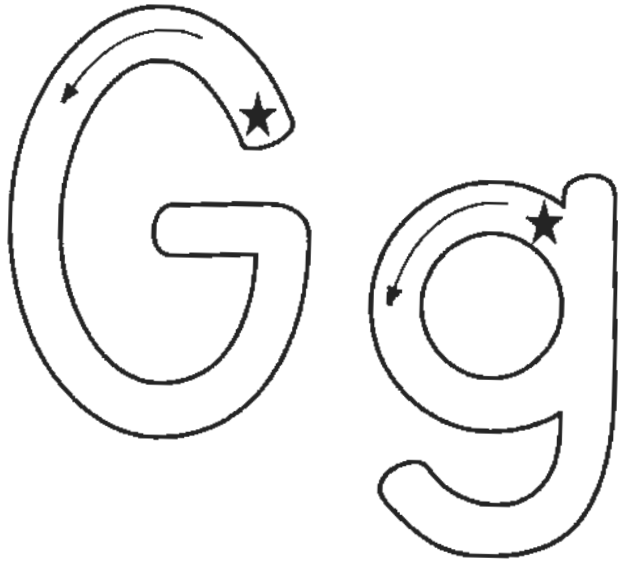

Find the letter

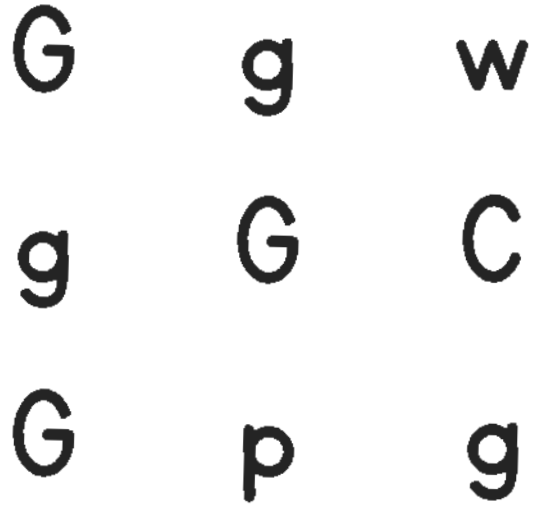

Color the pictures



gown

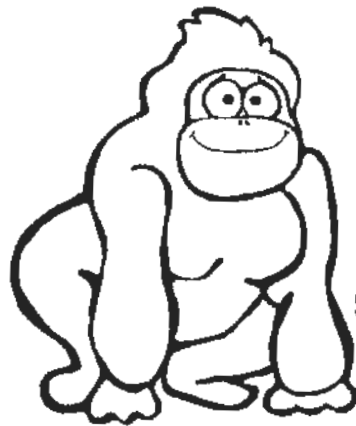

gorilla

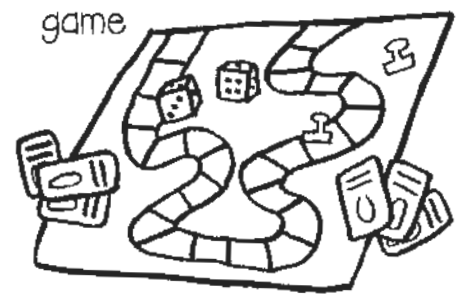

game



gum



goat



girl

Make a pattern

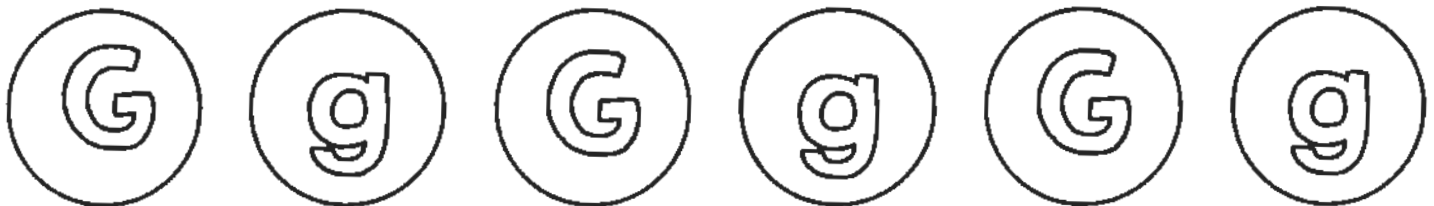

Letter Hh Activity Sheet

Trace the letter

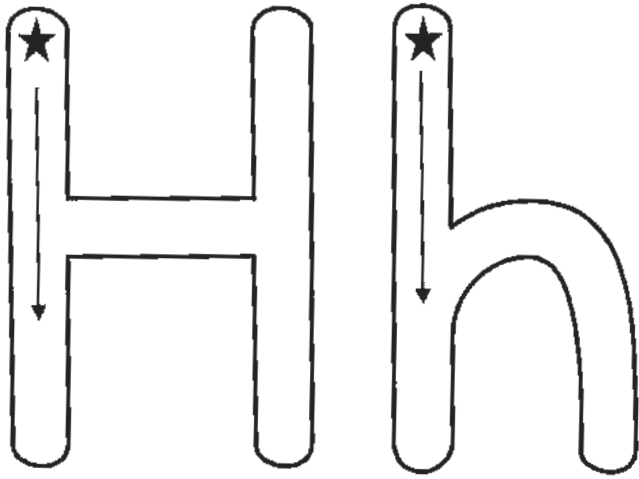

Find the letter

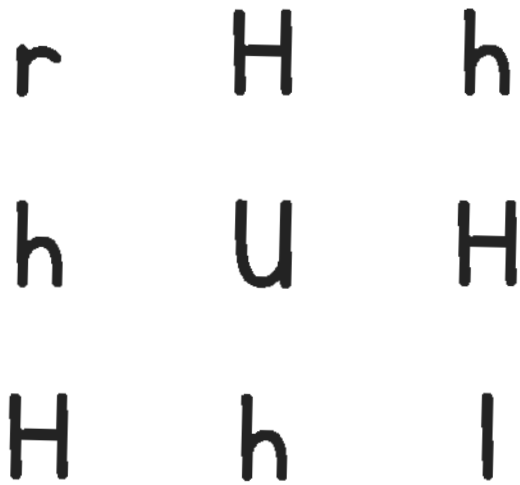

Color the pictures

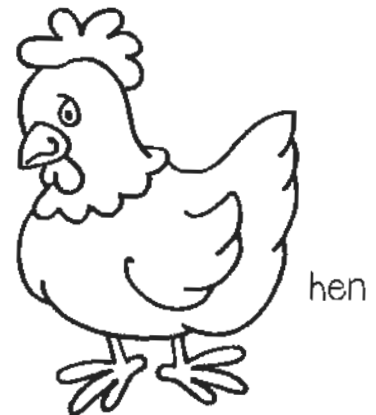
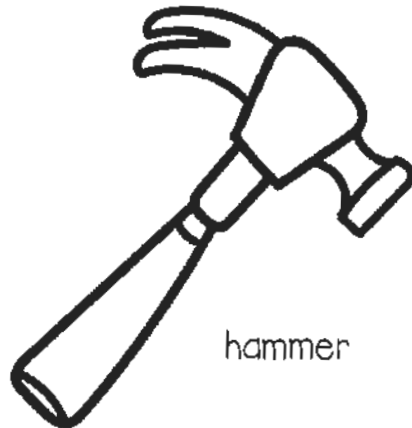
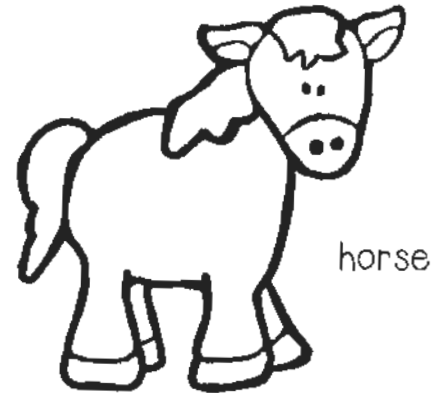
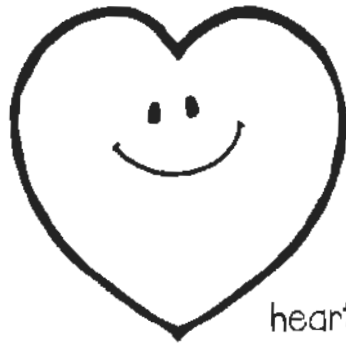
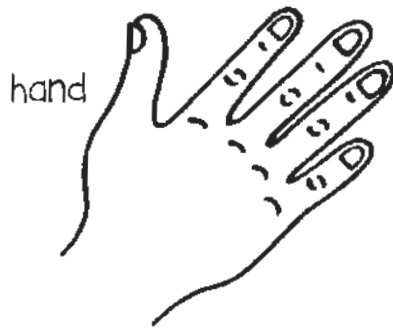

Make a pattern

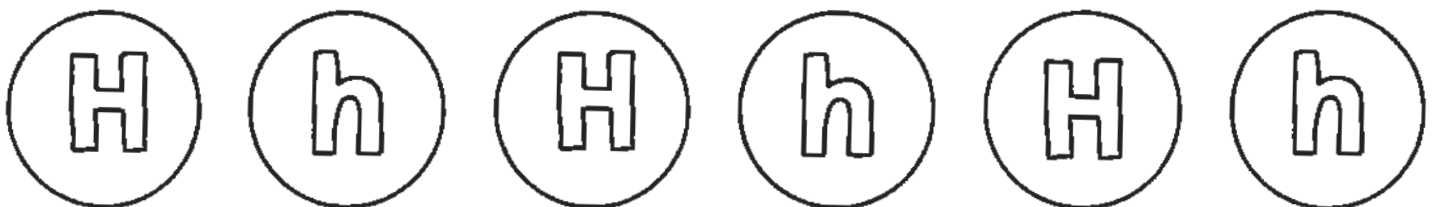

Letter Ii Activity Sheet

Trace the letter

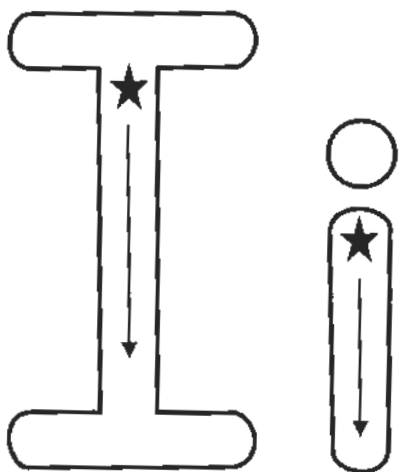

Find the letter

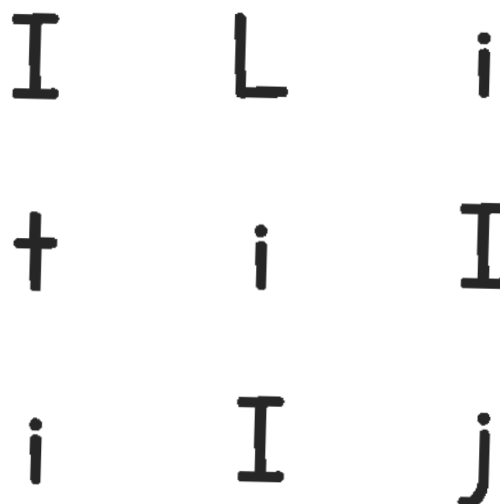

Color the pictures



interstate

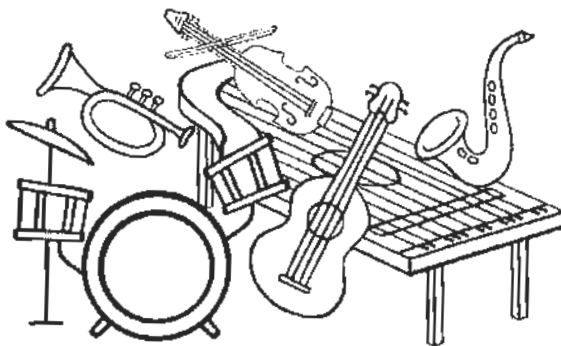

instruments

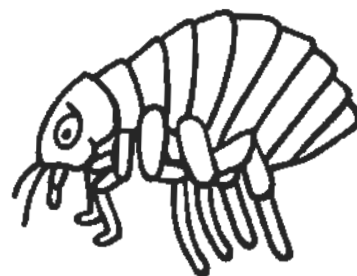

insect



itch

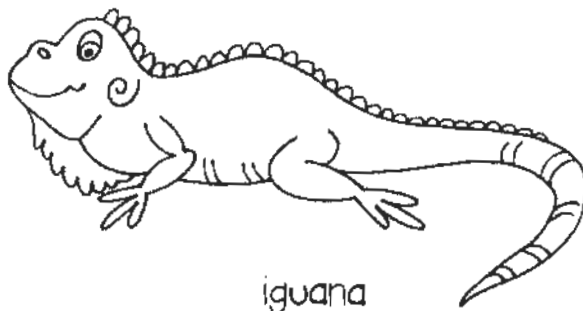

iguana

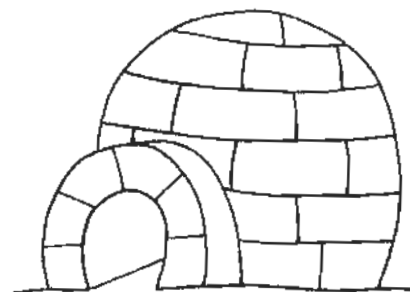

igloo

Make a pattern

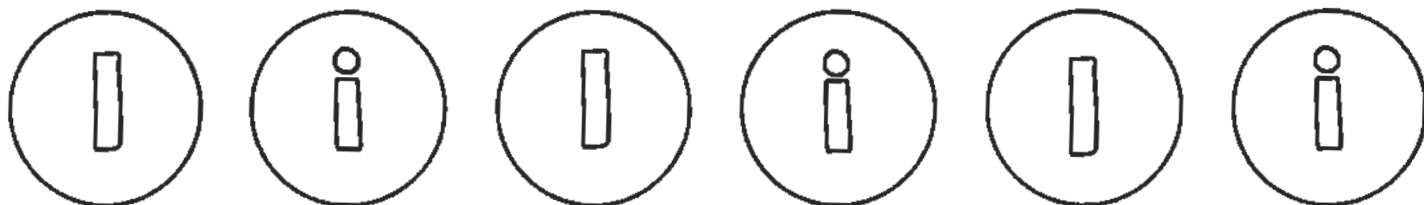

Letter Jj Activity Sheet

Trace the letter

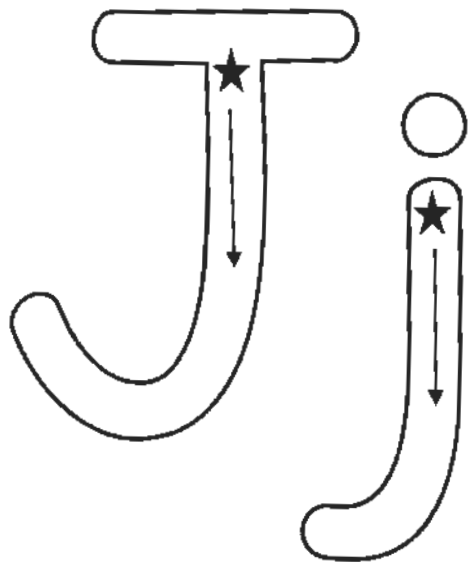

Find the letter

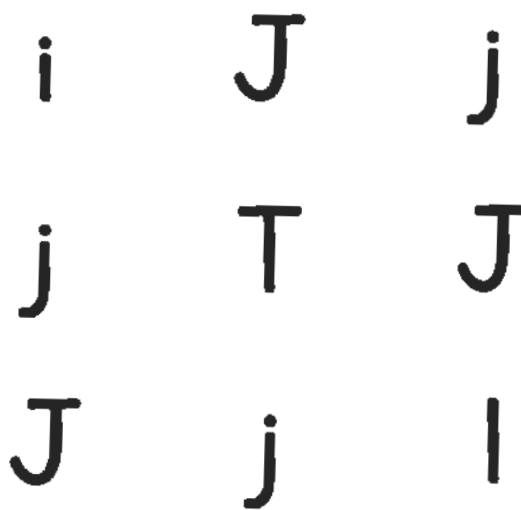

Color the pictures



jelly



jet



jog

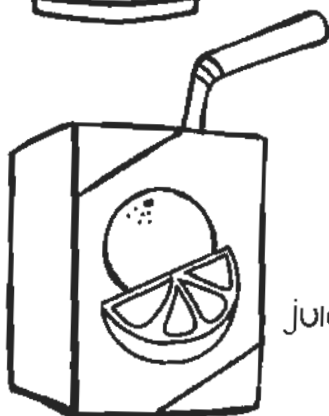

juice



jelly beans



jug

Make a pattern

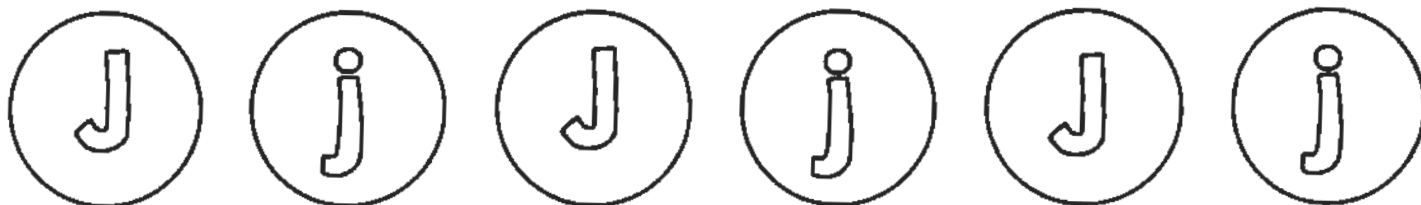

Letter Kk Activity Sheet

Trace the letter

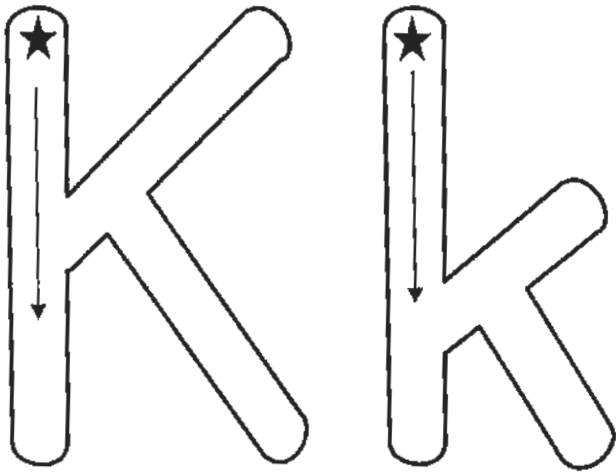

Find the letter

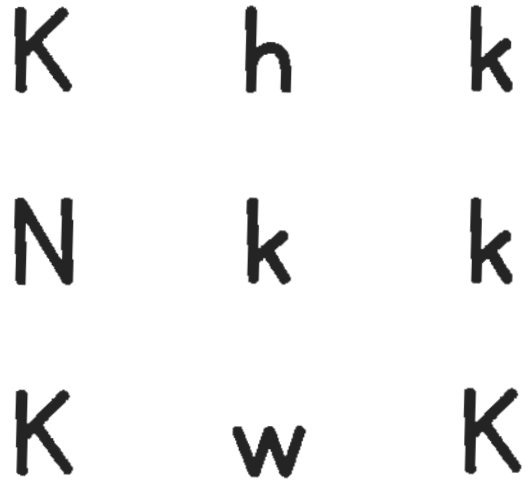

Color the pictures

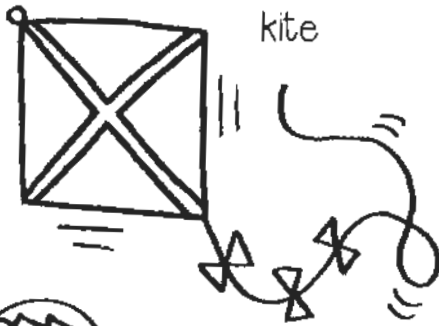

kite

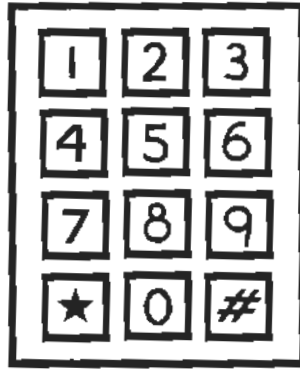

keypad

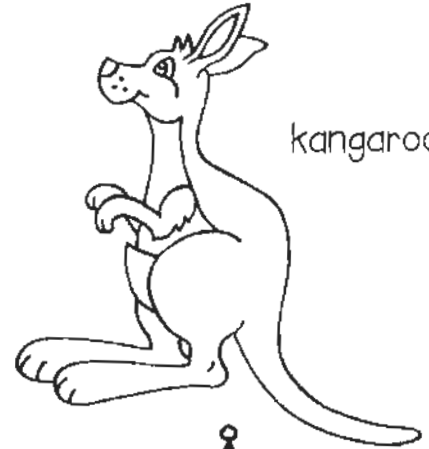

kangaroo

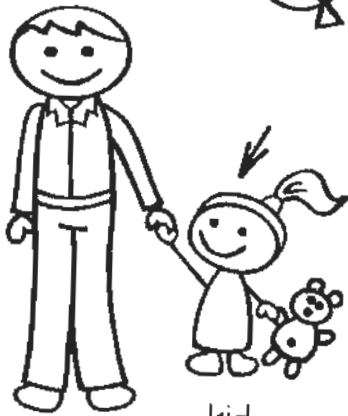

kid



kitten

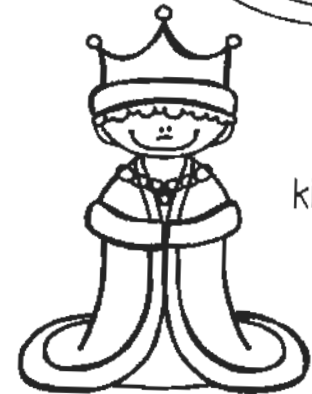

king

Make a pattern

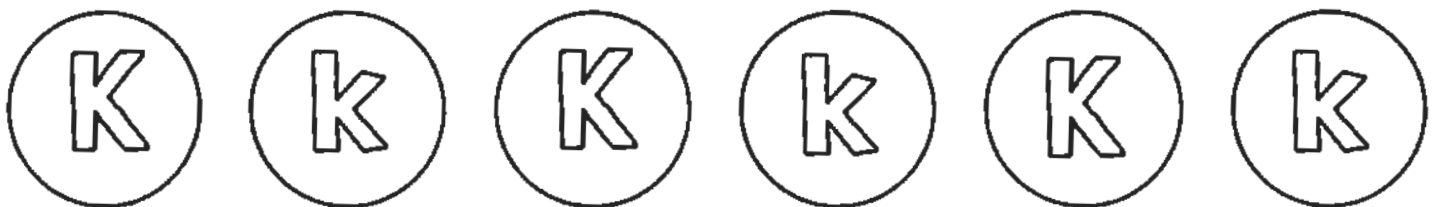

Letter LI Activity Sheet

Trace the letter

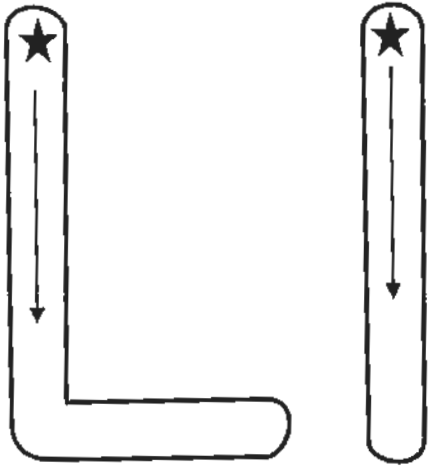

Find the letter

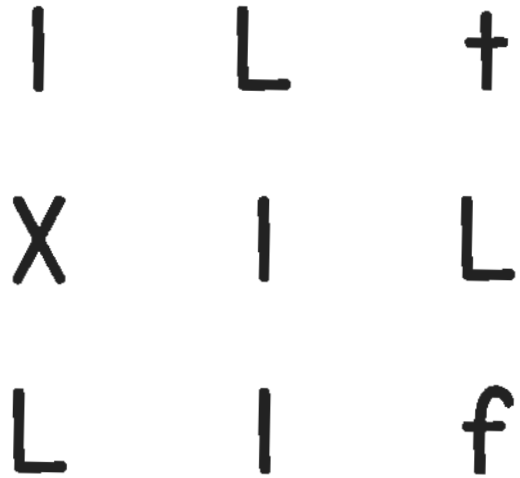

Color the pictures

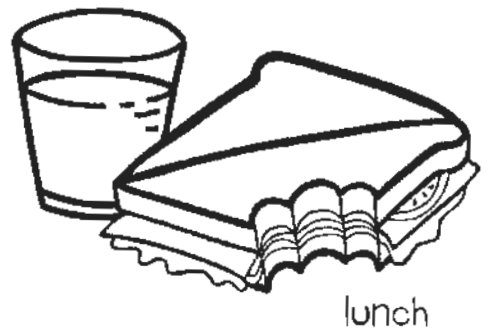
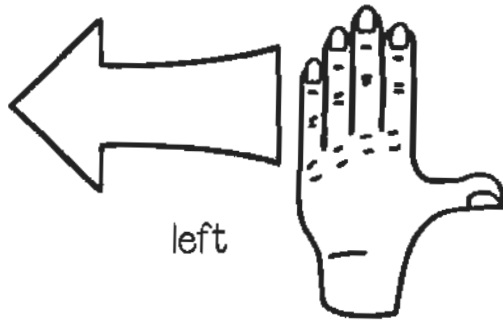
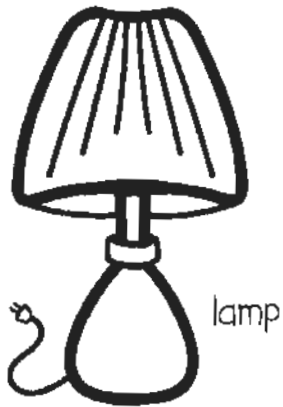
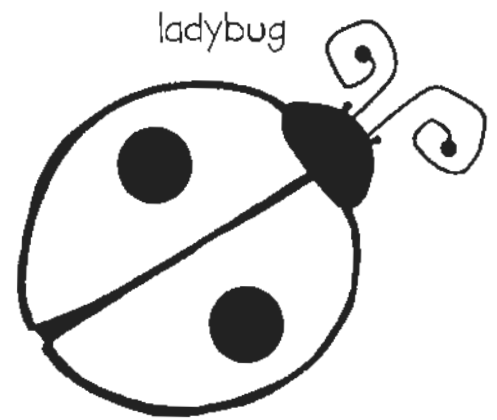
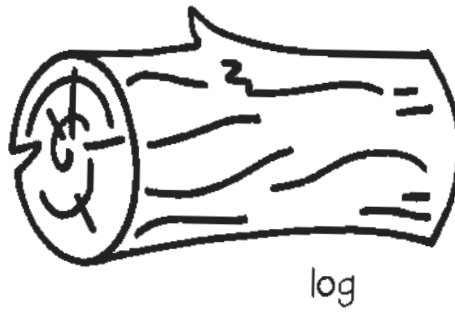
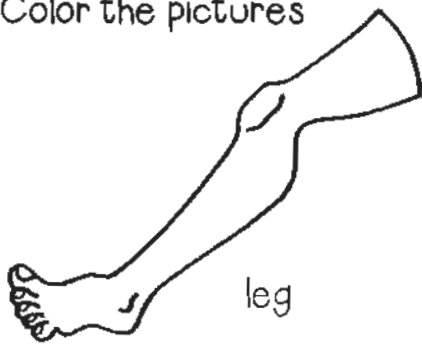

Make a pattern



Letter Mm Activity Sheet

Trace the letter

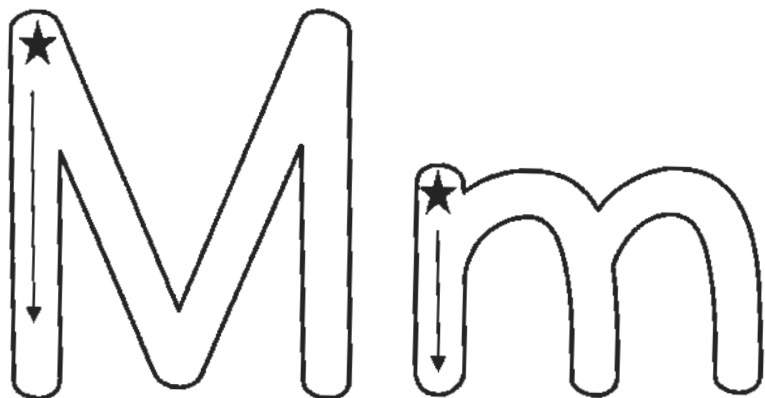

Find the letter

M m u
Z N m
M m M

Color the pictures

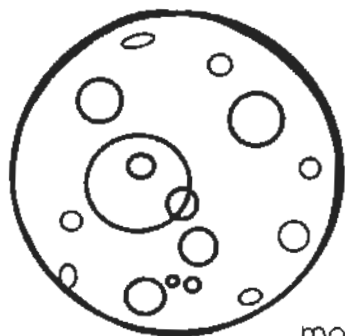

moon



mail



mushroom

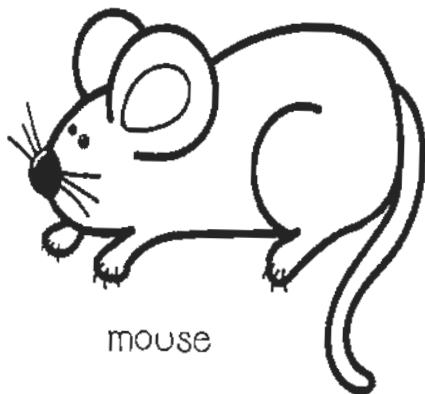

mouse



muffin



mop

Make a pattern

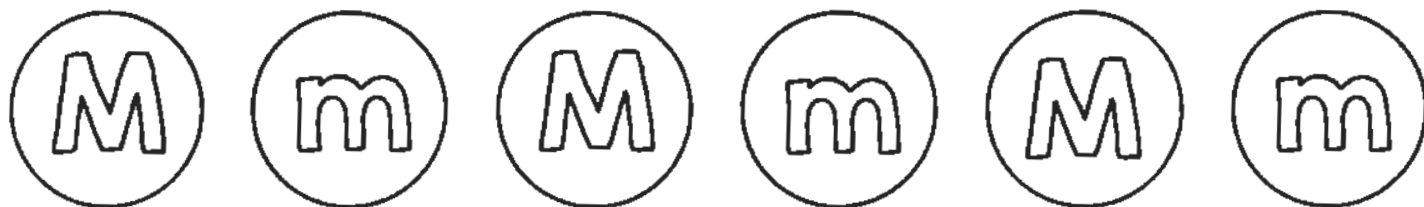

Letter Nn Activity Sheet

Trace the letter

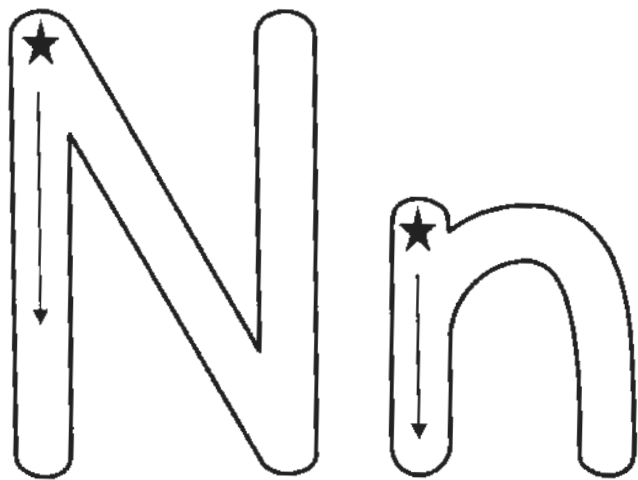

Find the letter

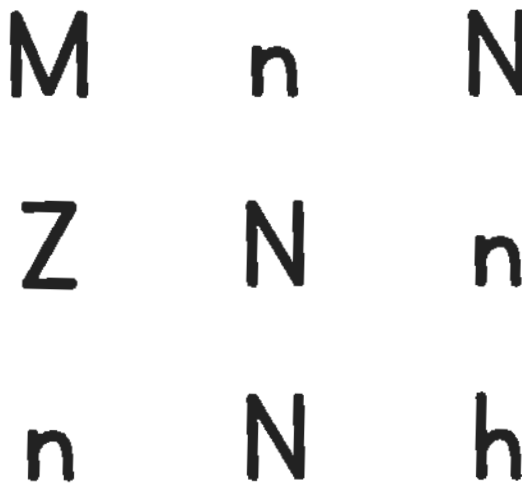

Color the pictures

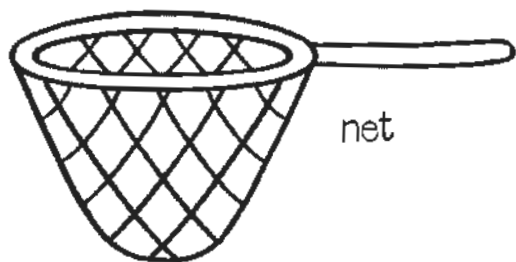

net



nine



nail

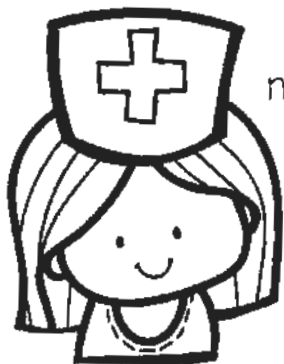

nurse



nest



nose

Make a pattern

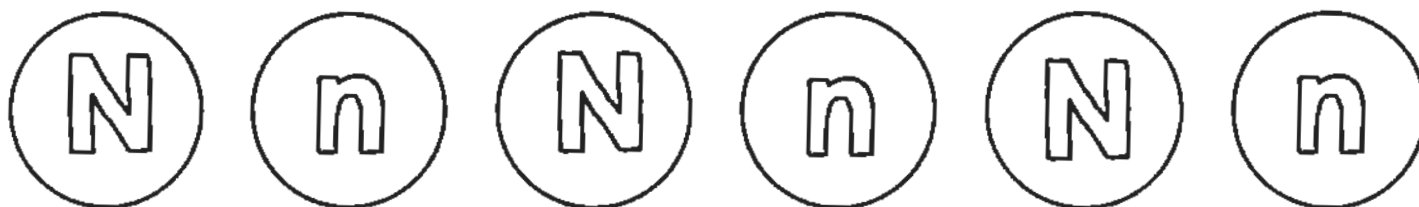

Letter Oo Activity Sheet

Trace the letter

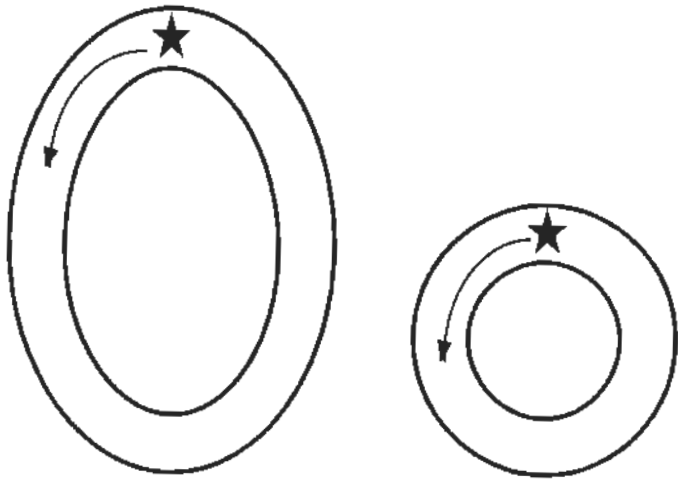

Find the letter

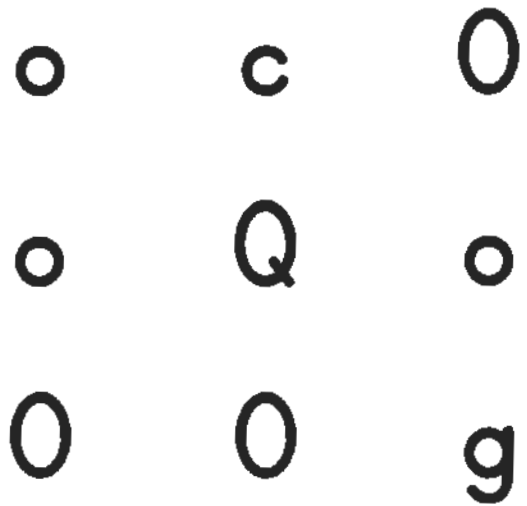

Color the pictures

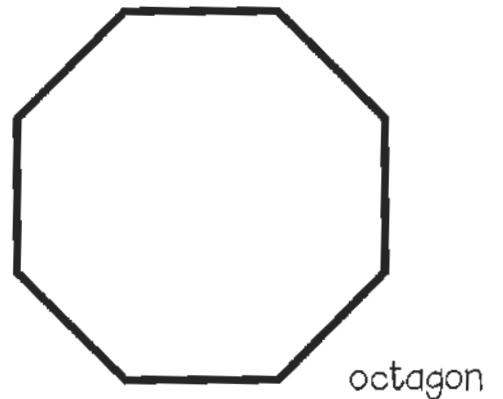
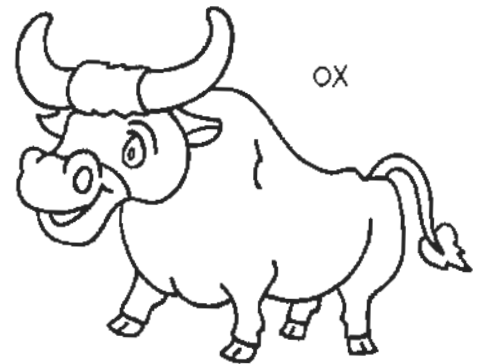
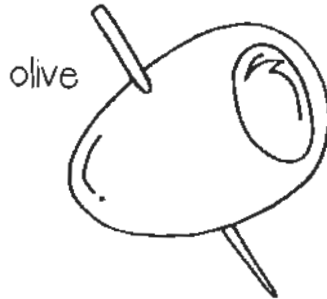

Make a pattern

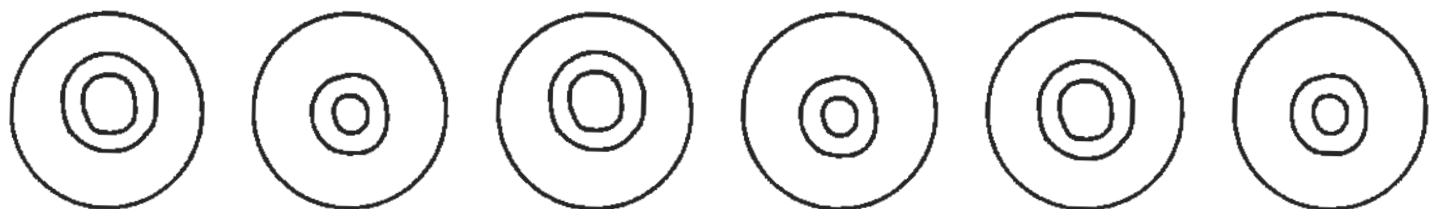

Letter Pp Activity Sheet

Trace the letter

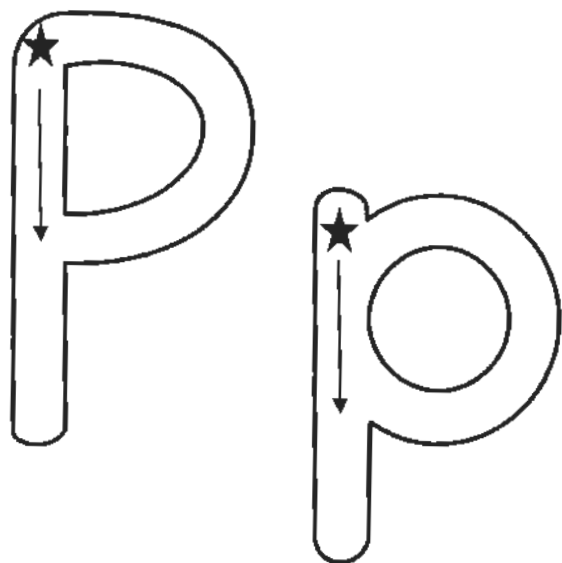

Find the letter

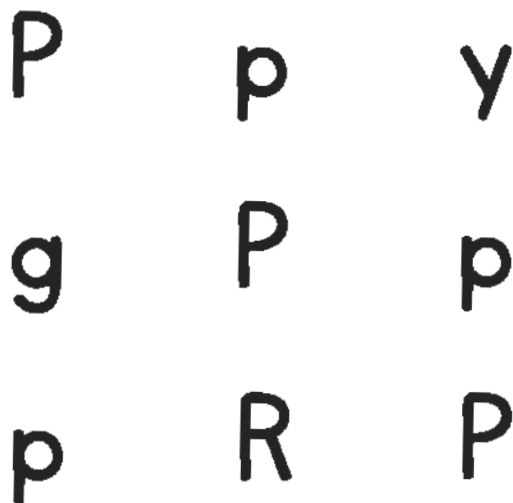

Color the pictures

pizza

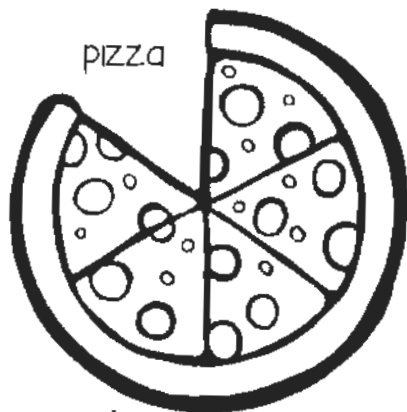

pumpkin



pencil

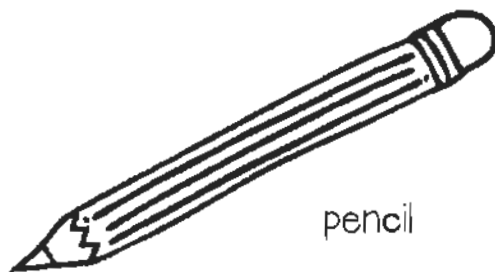

pot

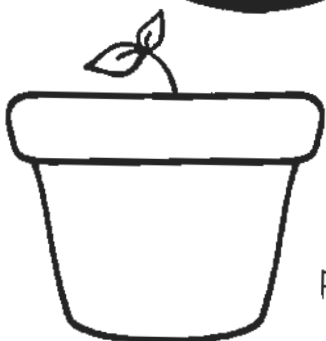

pig

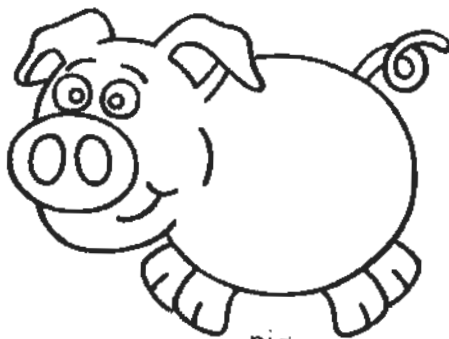

popcorn

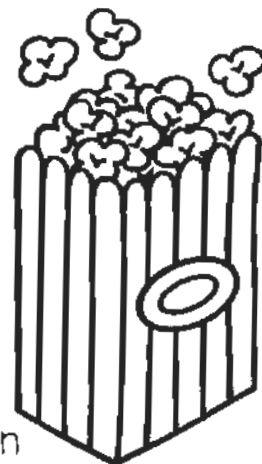

Make a pattern

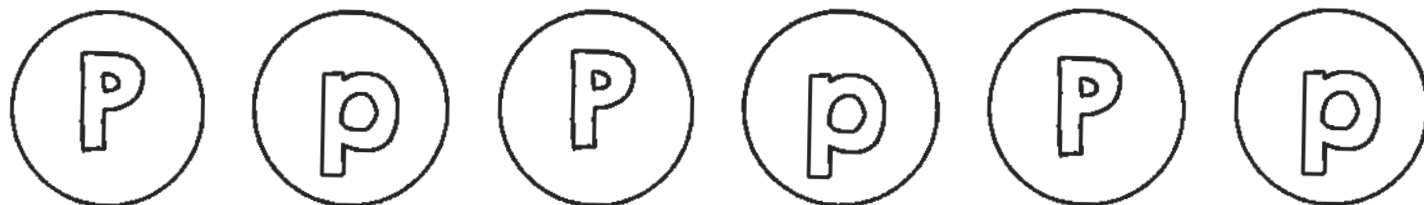

Letter Qq Activity Sheet

Trace the letter

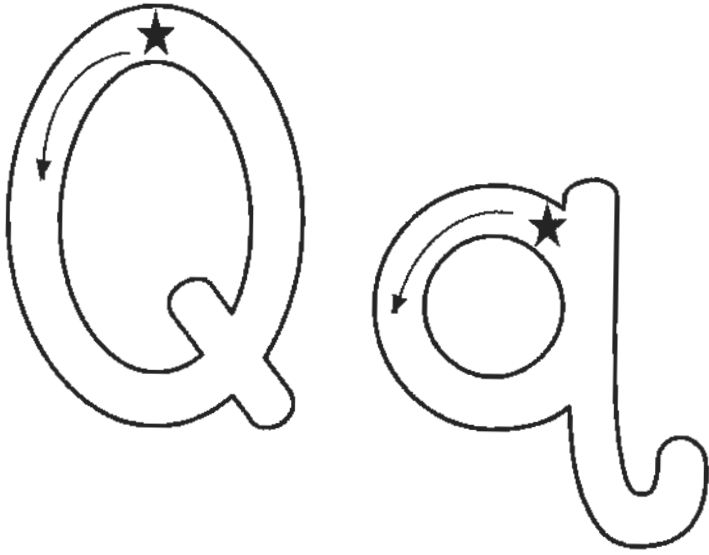

Find the letter

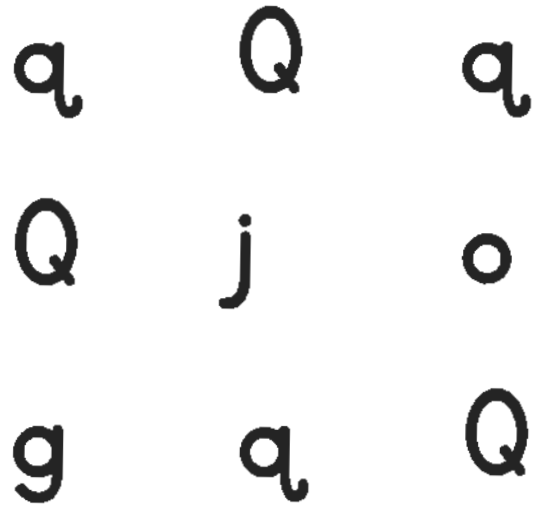

Color the pictures

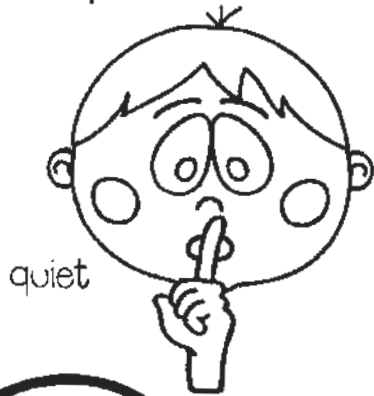

quiet



quarter

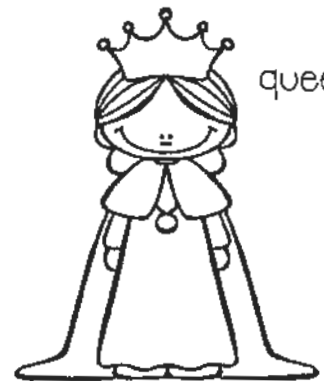

queen



question

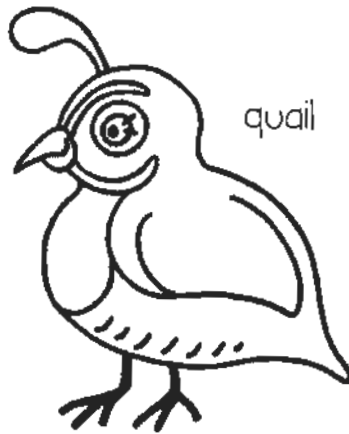

quail

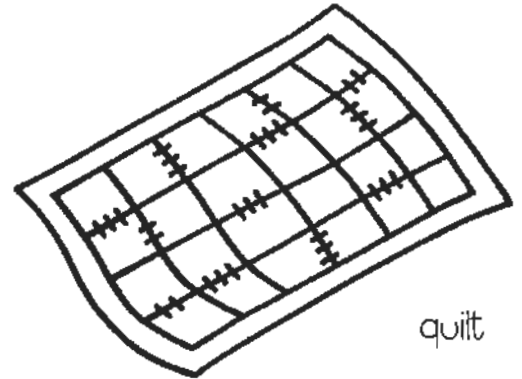

quilt

Make a pattern

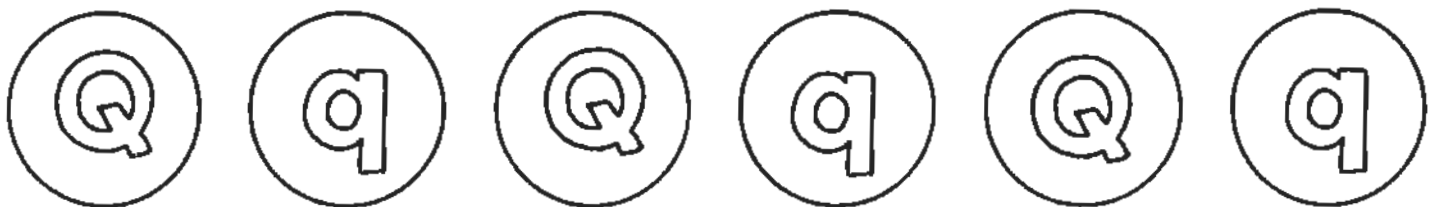

Letter Rr Activity Sheet

Trace the letter

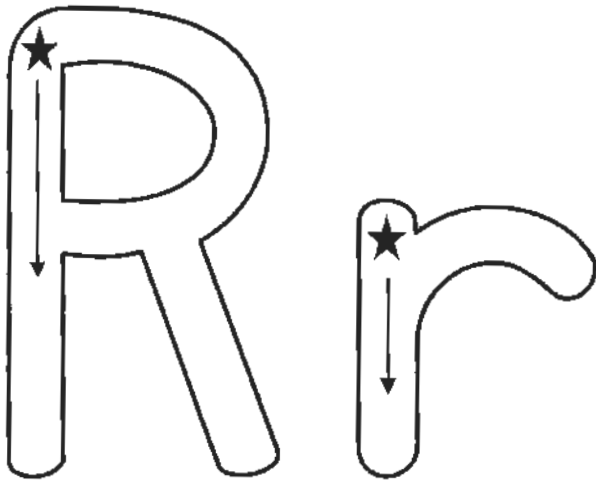

Find the letter

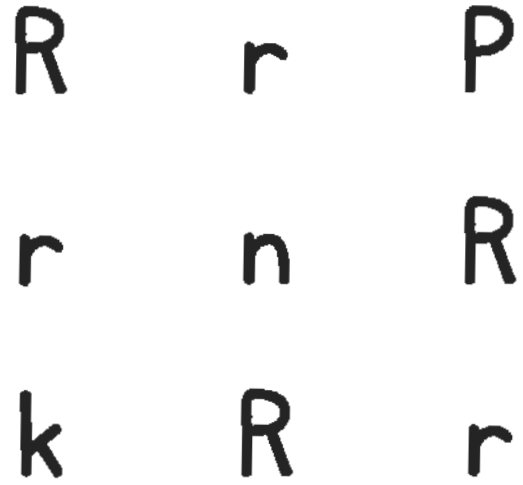

Color the pictures

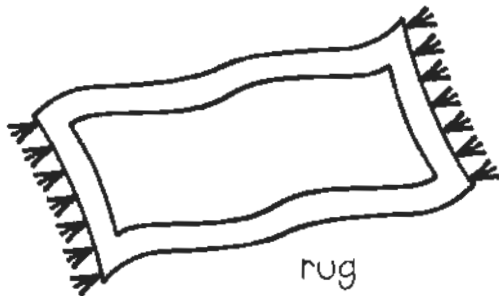

rug

rain



rocket

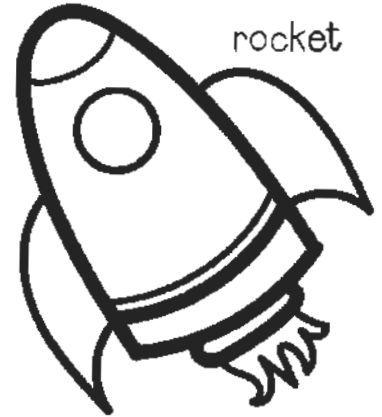

ring

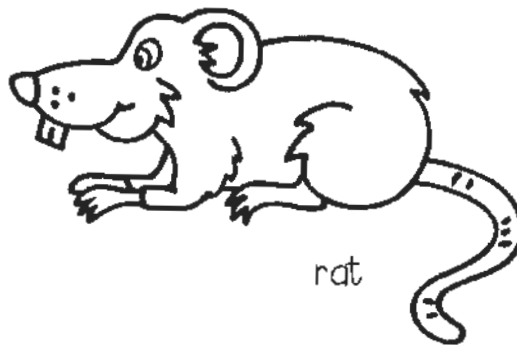

rat

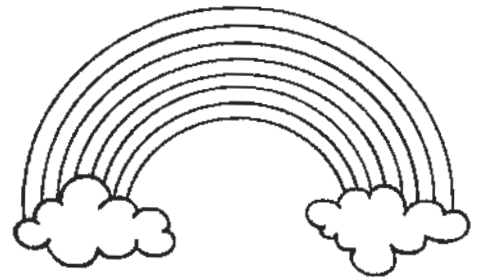

rainbow

Make a pattern

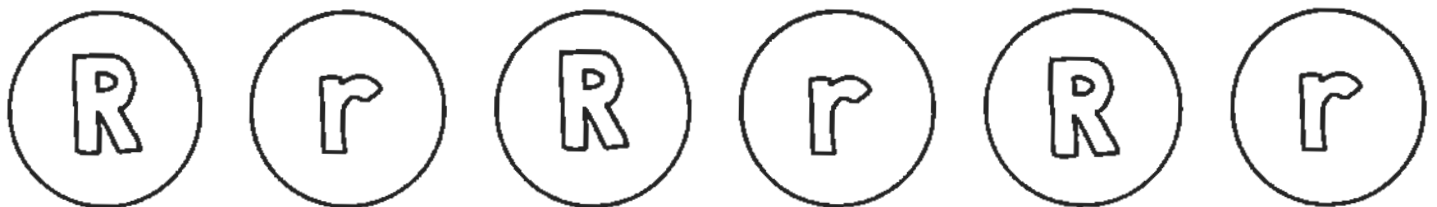

Letter Ss Activity Sheet

Trace the letter

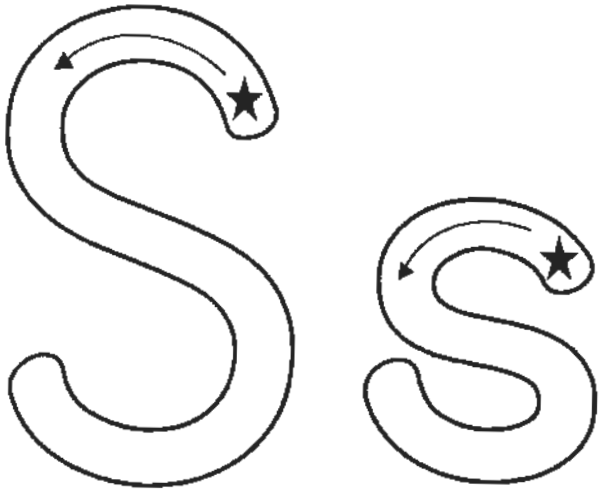

Find the letter

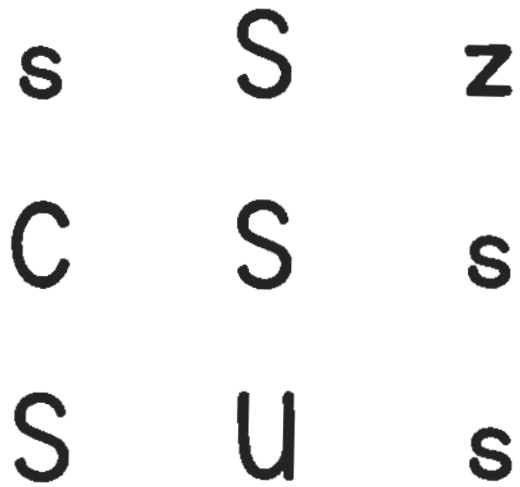

Color the pictures

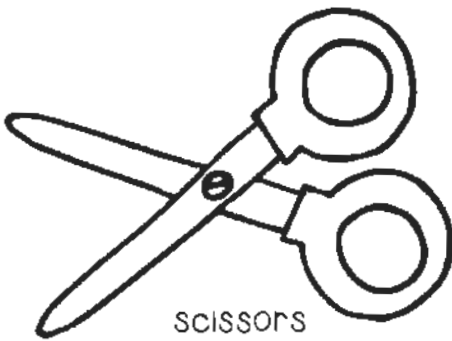

scissors



sock

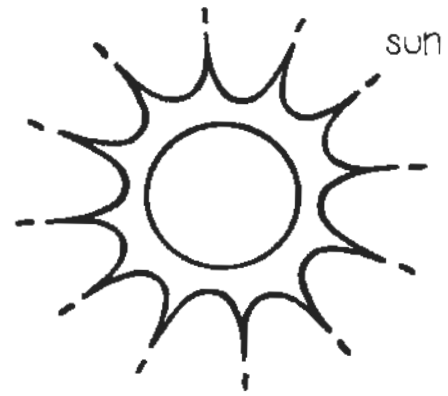

sun



soap



six

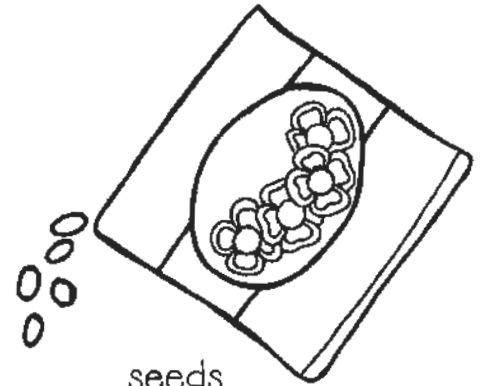

seeds

Make a pattern

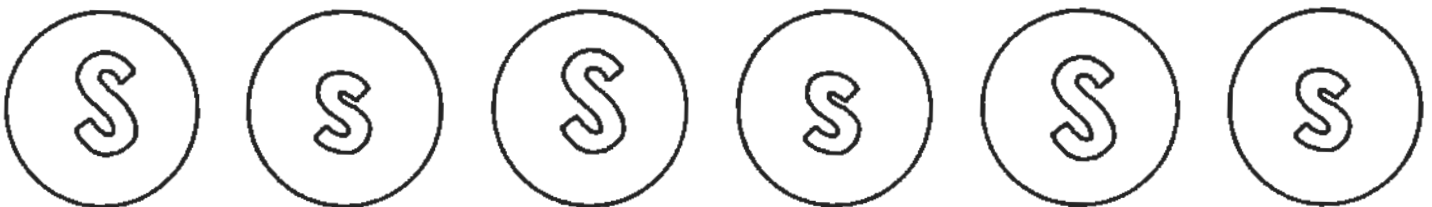

Letter Tt Activity Sheet

Trace the letter

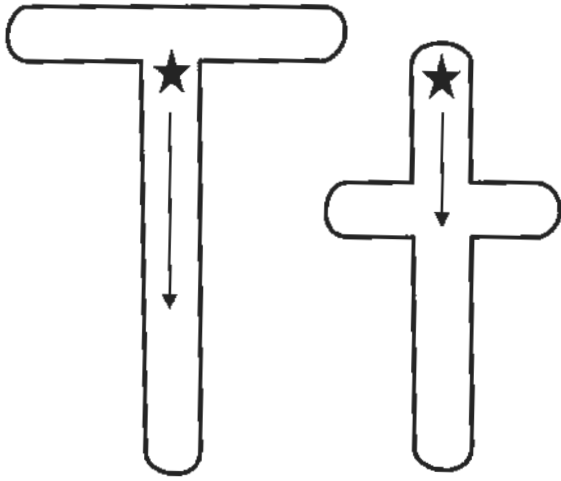

Find the letter

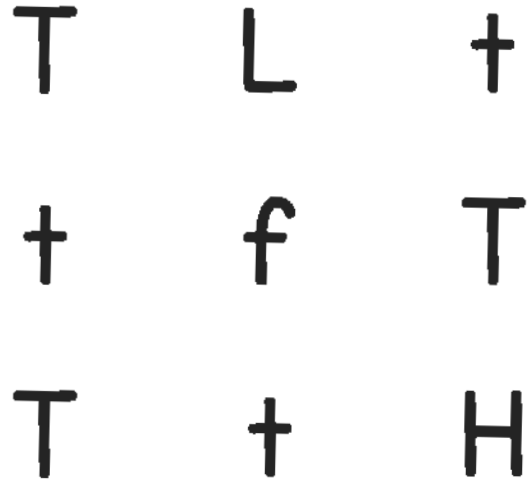

Color the pictures

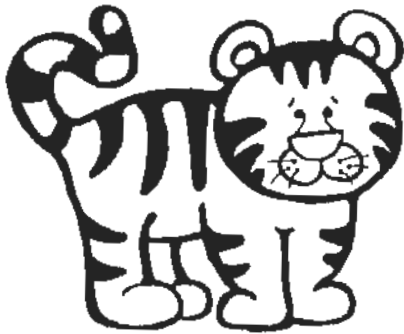

tiger

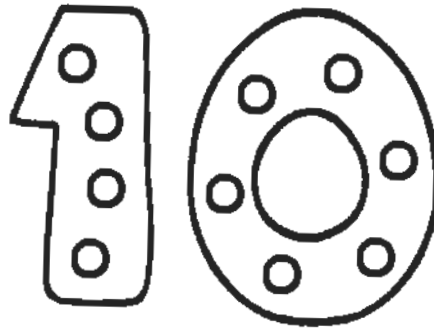

ten



toe

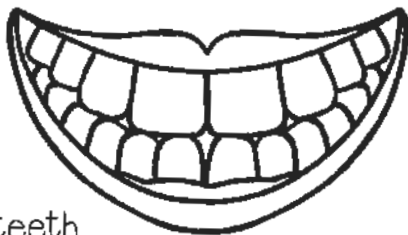

teeth



tent

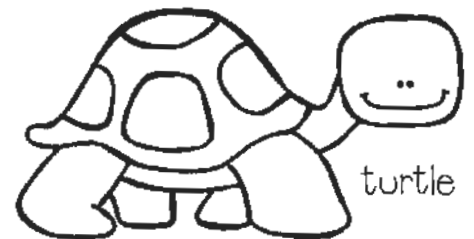

turtle

Make a pattern

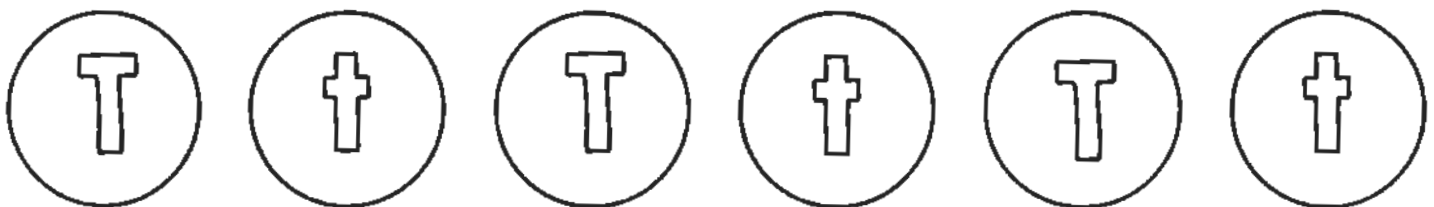

Letter Uu Activity Sheet

Trace the letter

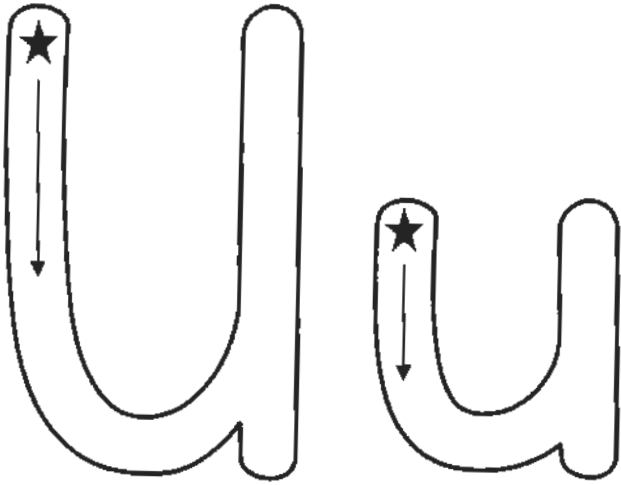

Find the letter

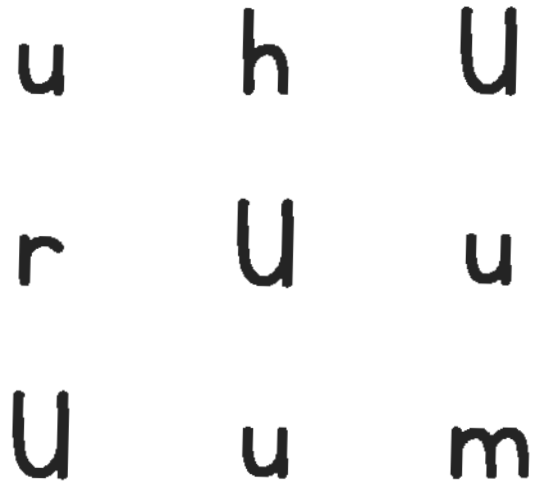

Color the pictures

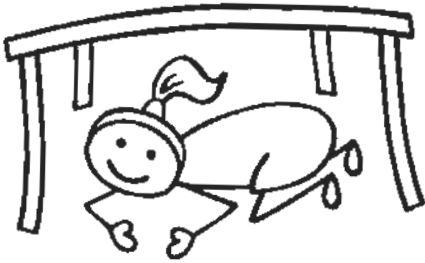

under



umpire

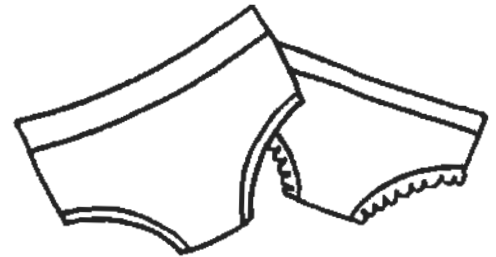

underwear



umbrella

abcde

underline



up

Make a pattern

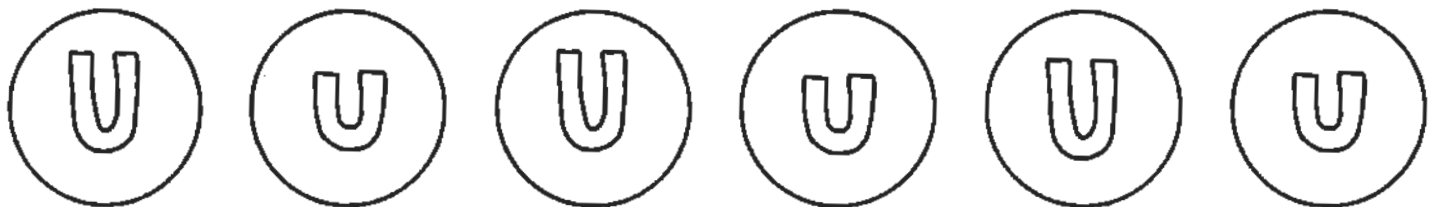

Letter Vv Activity Sheet

Trace the letter

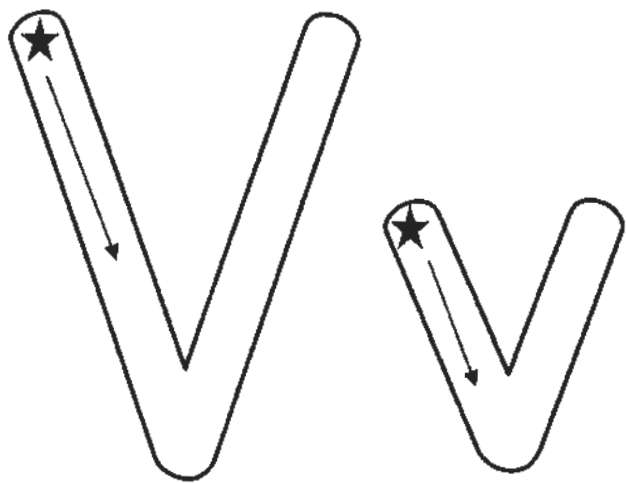

Find the letter

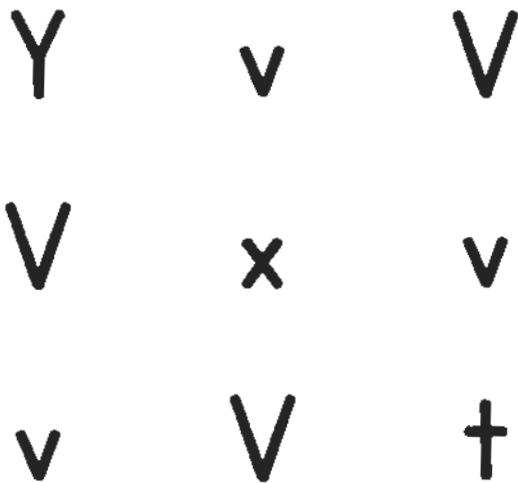

Color the pictures

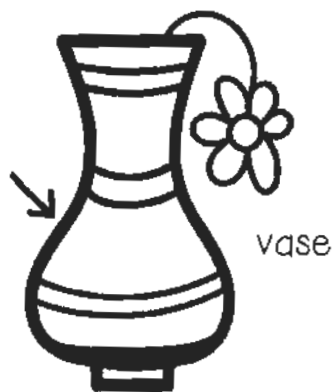
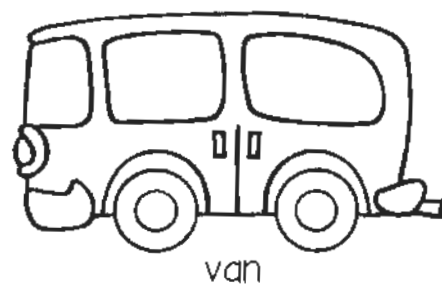

Make a pattern

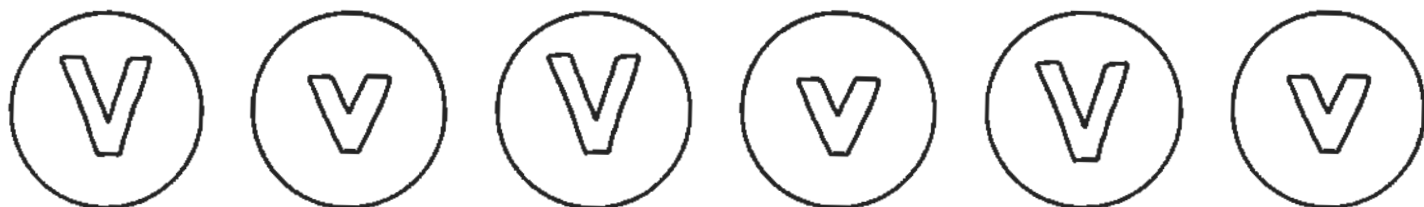

Letter Ww Activity Sheet

Trace the letter

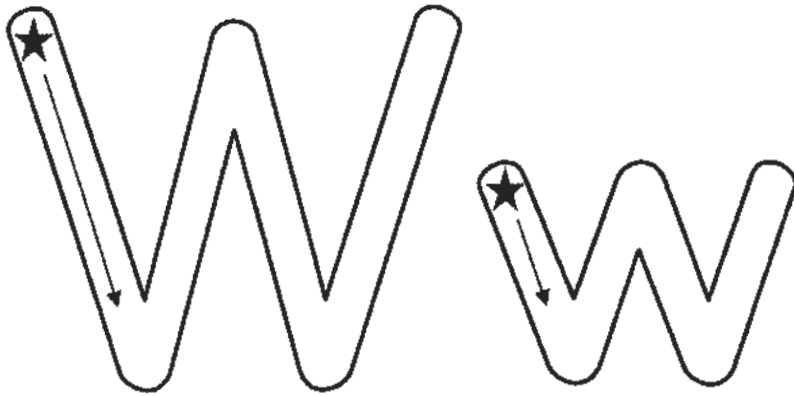

Find the letter

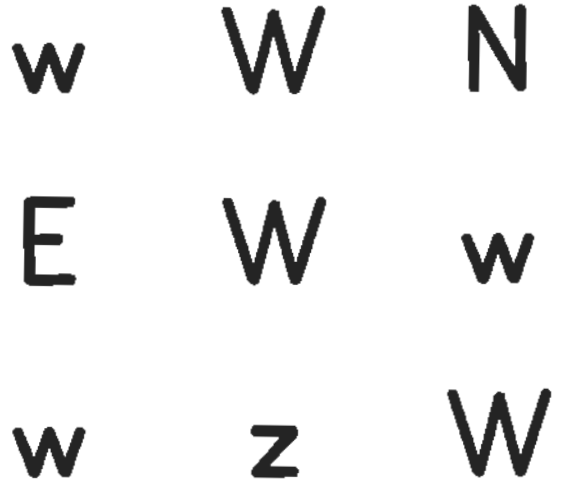

Color the pictures

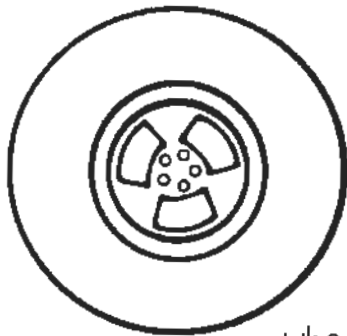

wheel

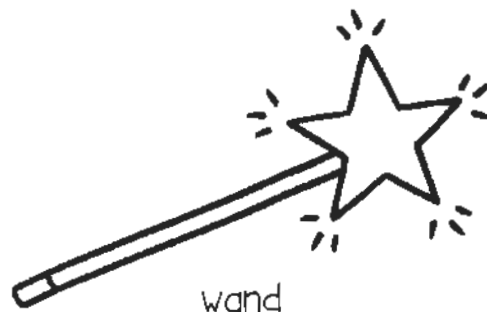

wand

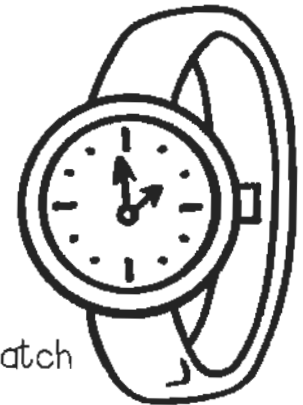

watch



wave

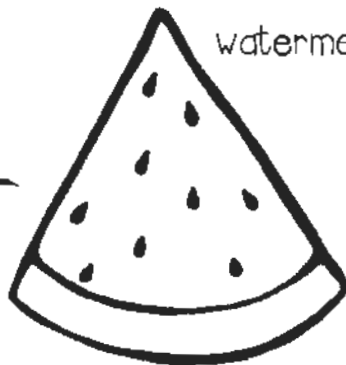

watermelon

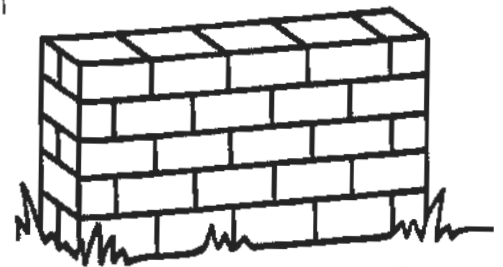

wall

Make a pattern

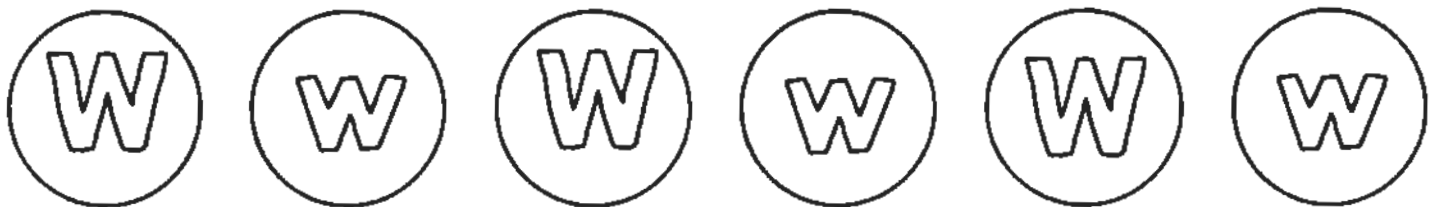

Letter Xx Activity Sheet

Trace the letter

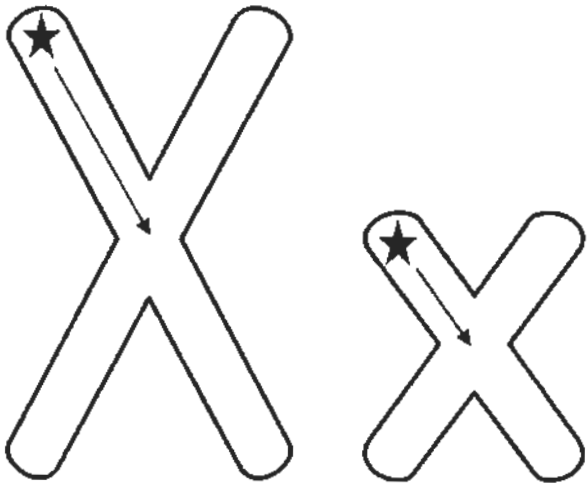

Find the letter

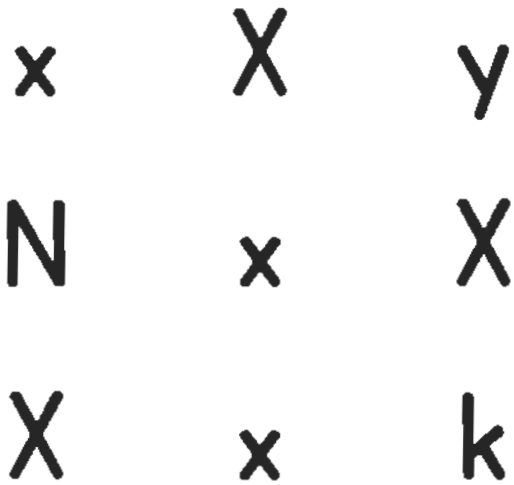

Color the pictures

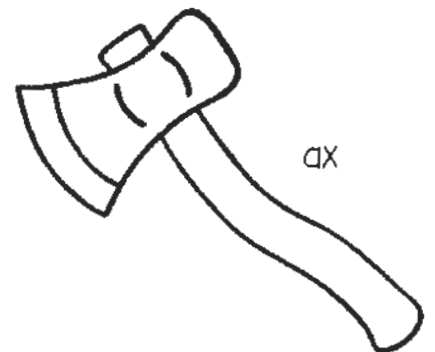
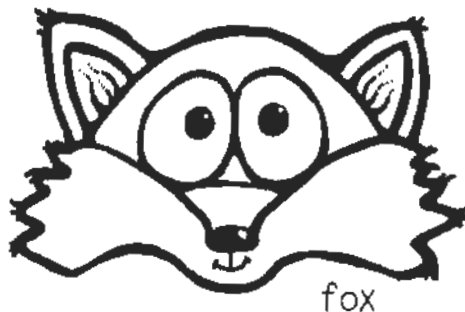
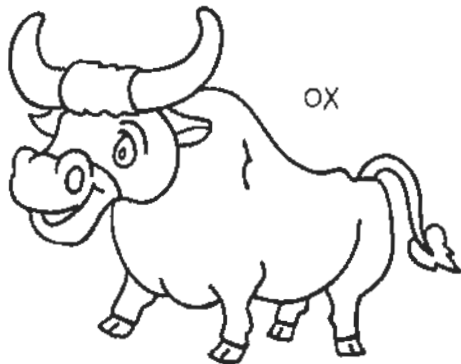
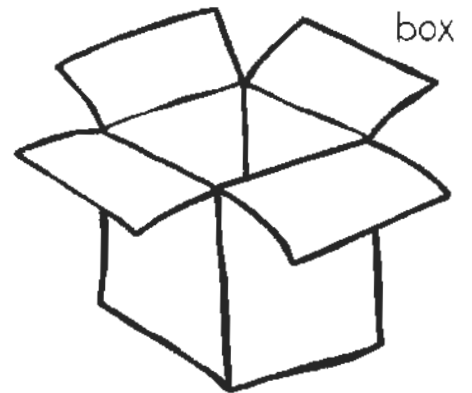
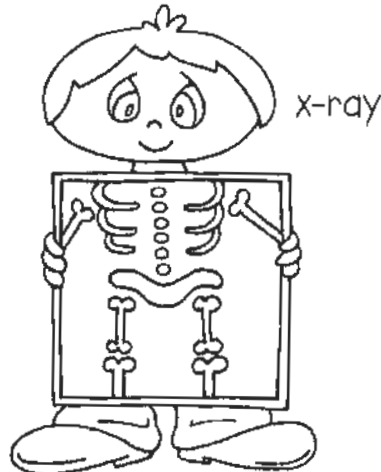
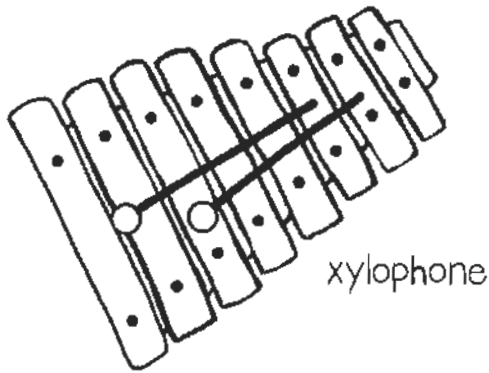

Make a pattern

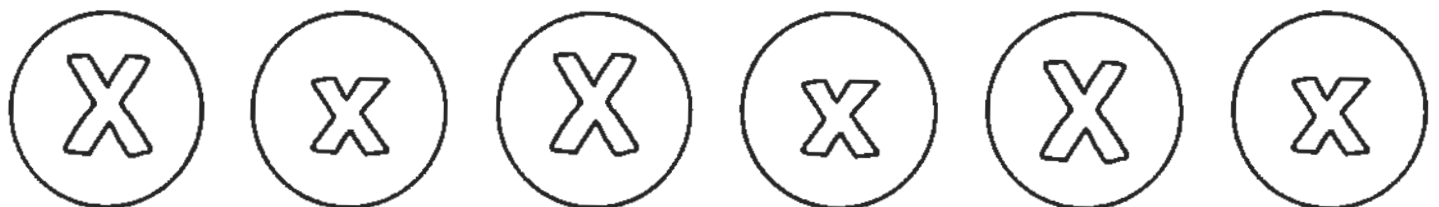

Letter Yy Activity Sheet

Trace the letter

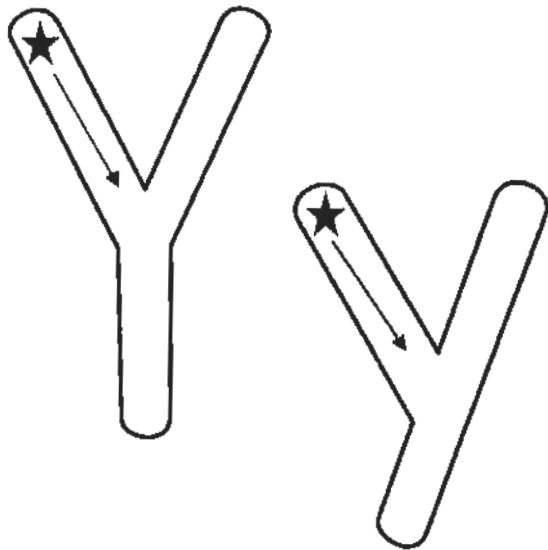

Find the letter

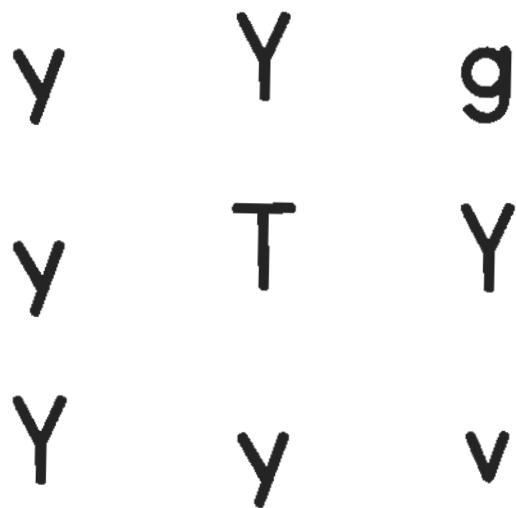

Color the pictures



yak



yolk

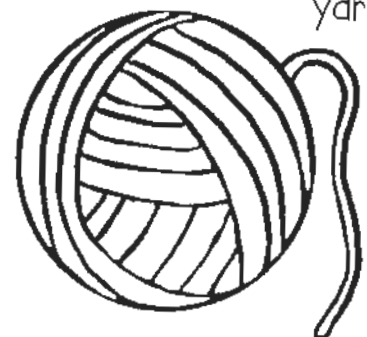

yarn

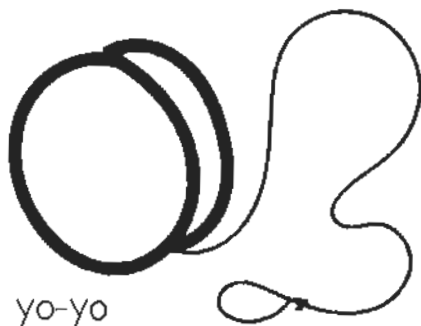

yo-yo

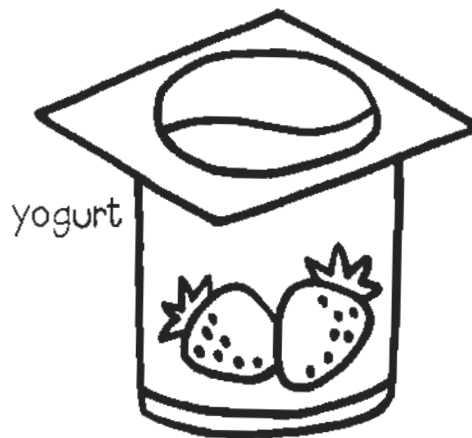

yogurt



yawn

Make a pattern

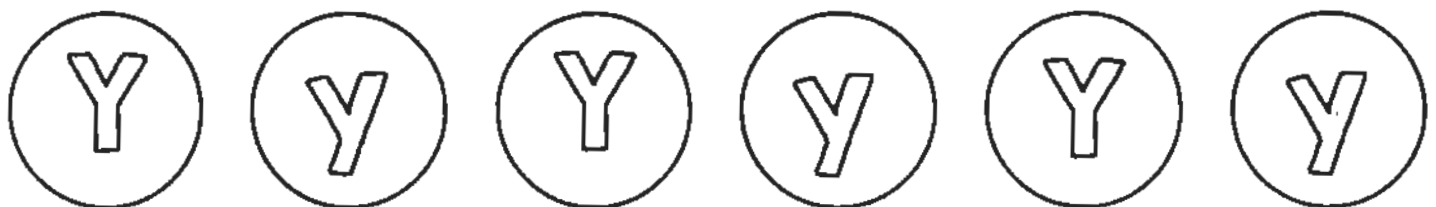

Letter Zz Activity Sheet

Trace the letter

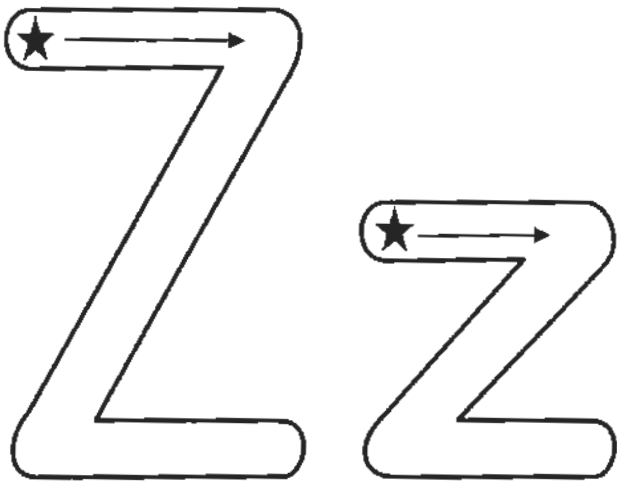

Find the letter

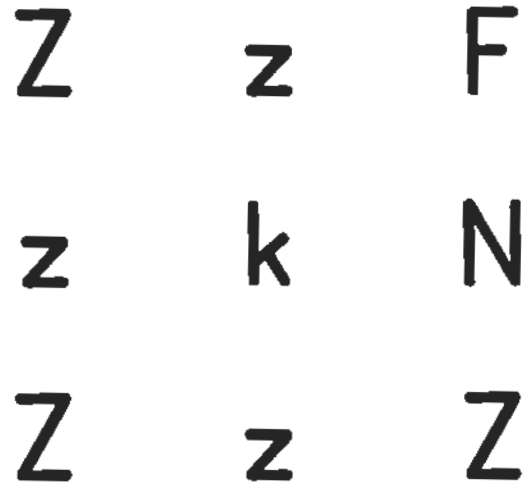

Color the pictures

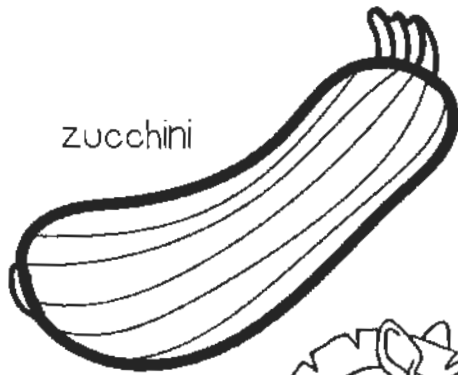

zucchini



zigzag

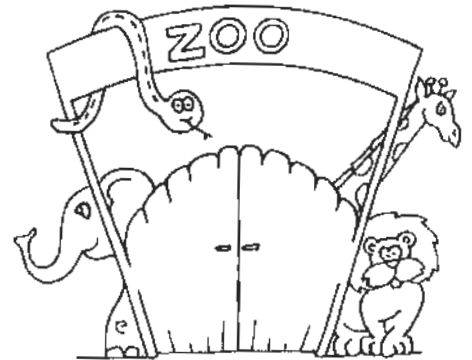

zoo



zebra

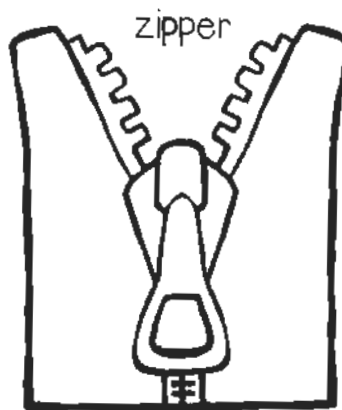

zipper

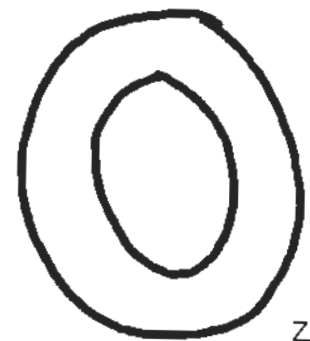

zero

Make a pattern

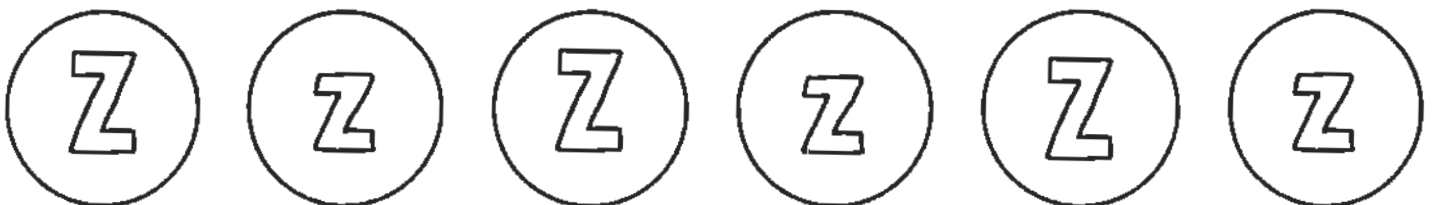

Name: _____

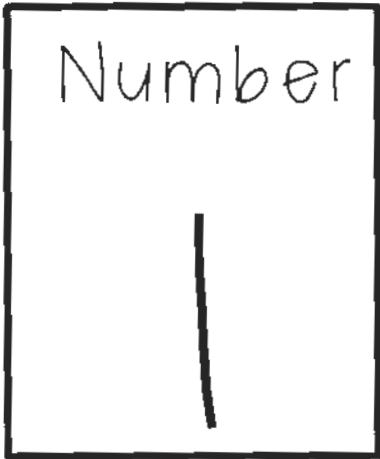

1. Trace



2. Write.

3. Color.



4. Circle.

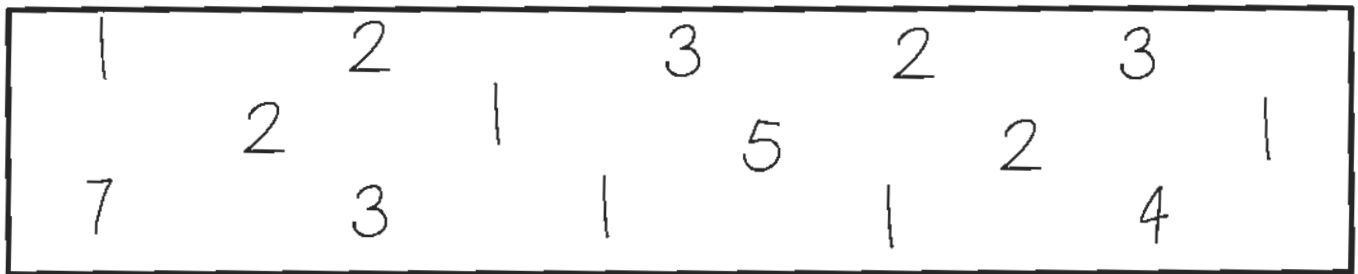

5. Color the squares to show the number 1 in the 10 frame.

| | | | | |
|--|--|--|--|--|
| | | | | |
| | | | | |

Name: _____

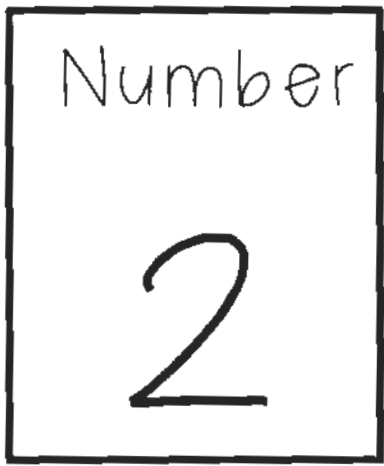

1. Trace



2. Write.

3. Color.



4. Circle.

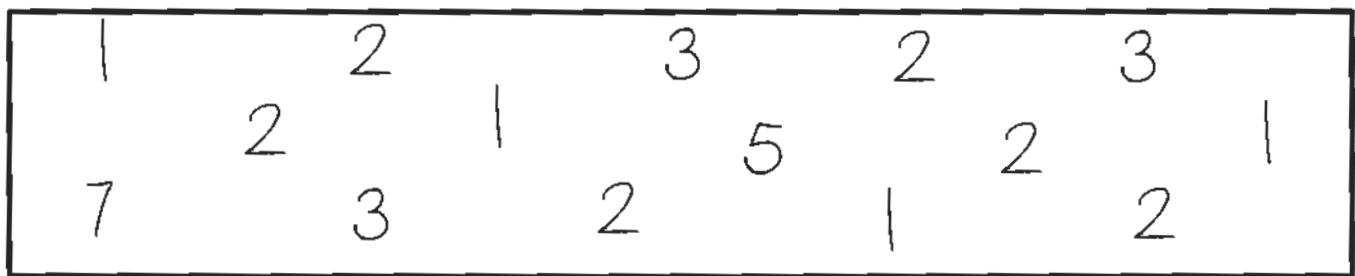

5. Color the squares to show the number 2 in the 10 frame.

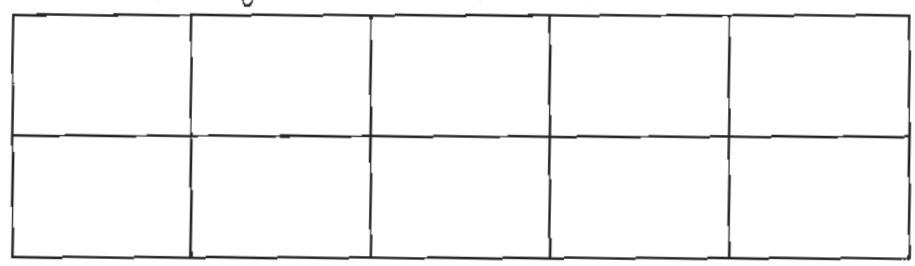

Name: _____

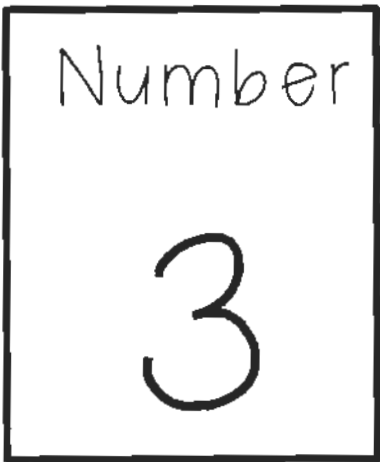

1. Trace



2. Write.

3. Color.



4. Circle.

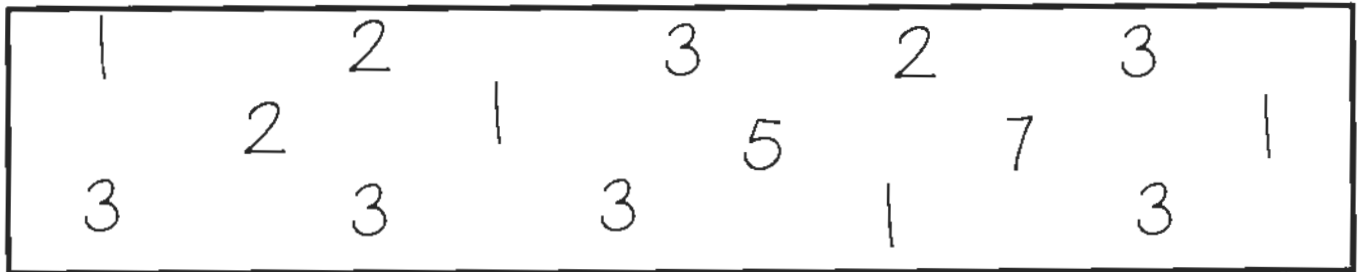

5. Color the squares to show the number 3 in the 10 frame.

| | | | | |
|--|--|--|--|--|
| | | | | |
| | | | | |

Name: _____

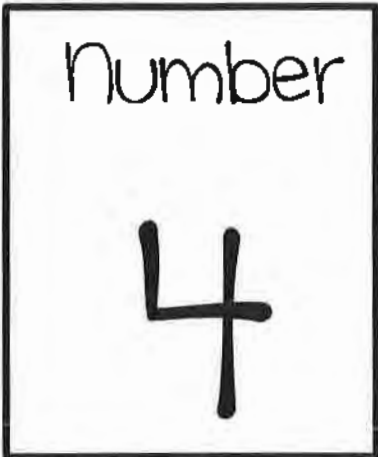

1. Trace



2. Write.

3. Color.

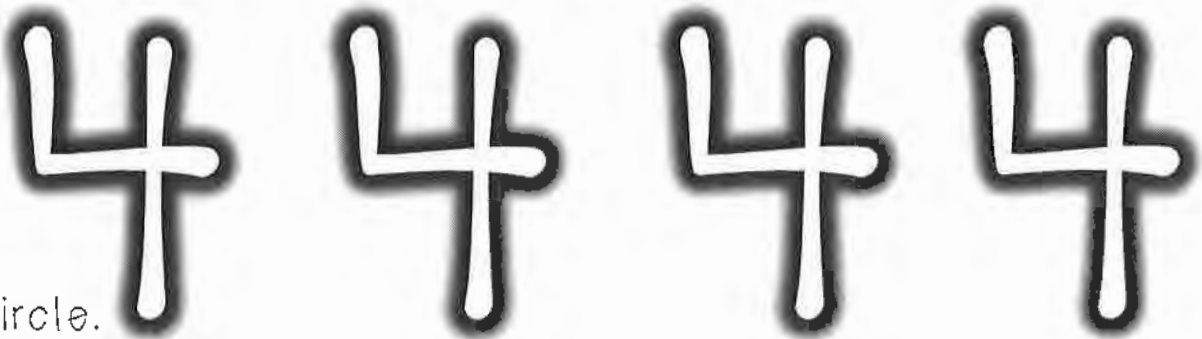

4. Circle.

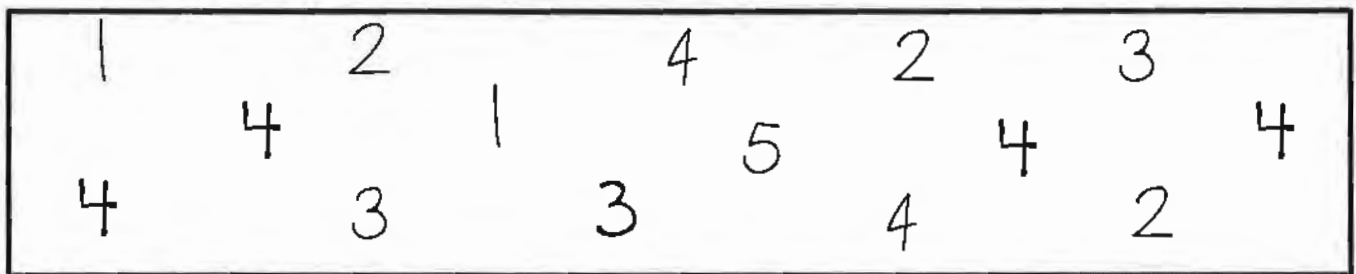

5. Color the squares to show the number 4 in the 10 frame.

| | | | | |
|--|--|--|--|--|
| | | | | |
| | | | | |

Name: _____

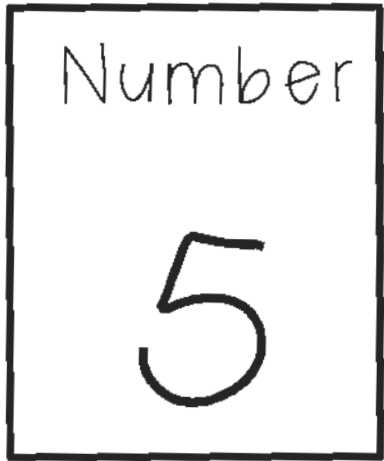

1. Trace



2. Write.

3. Color.



4. Circle.

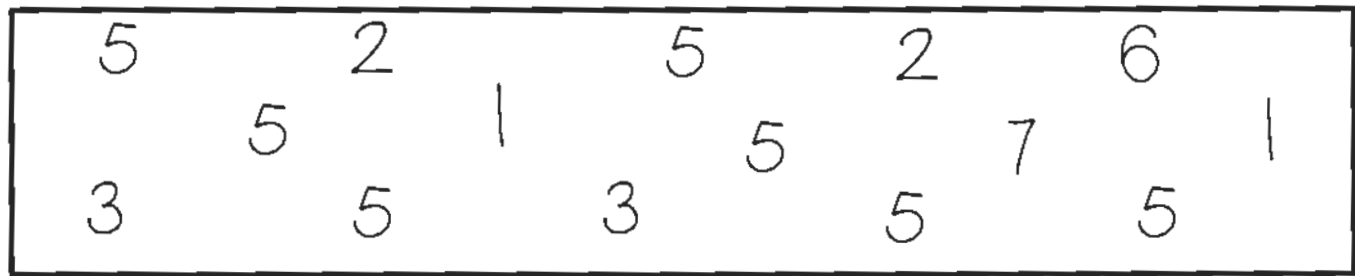

5. Color the squares to show the number 5 in the 10 frame.

| | | | | |
|--|--|--|--|--|
| | | | | |
| | | | | |

Name: _____

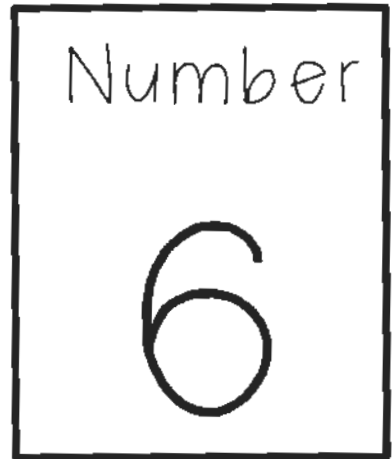

1. Trace



2. Write.

3. Color.



4. Circle.

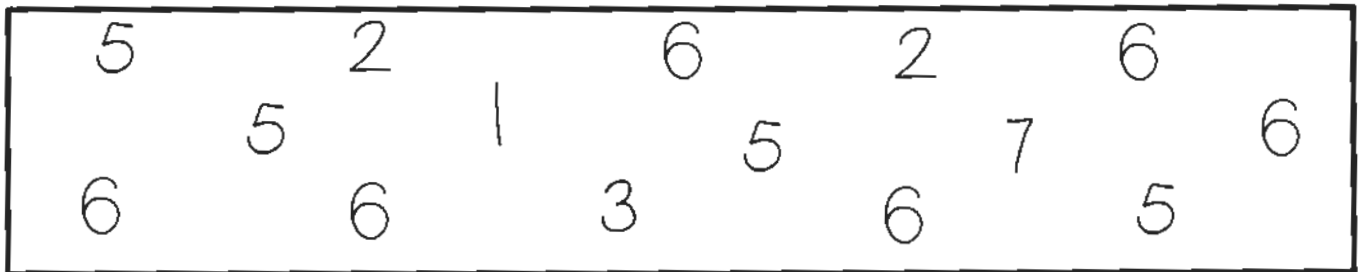

5. Color the squares to show the number 6 in the 10 frame.

| | | | | |
|--|--|--|--|--|
| | | | | |
| | | | | |

Name: _____



1. Trace

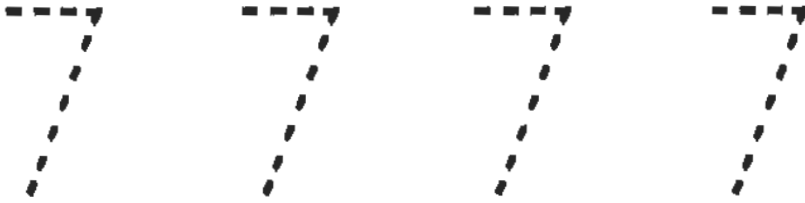

2. Write.

3. Color.



4. Circle.

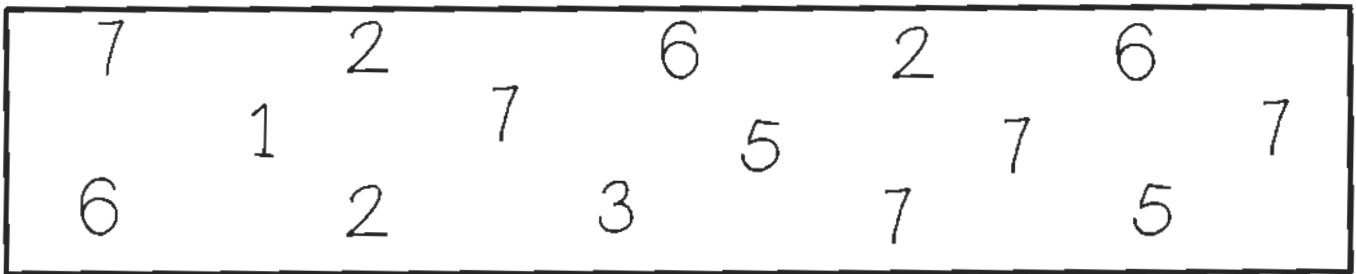

5. Color the squares to show the number 7 in the 10 frame.

| | | | | |
|--|--|--|--|--|
| | | | | |
| | | | | |

Name: _____

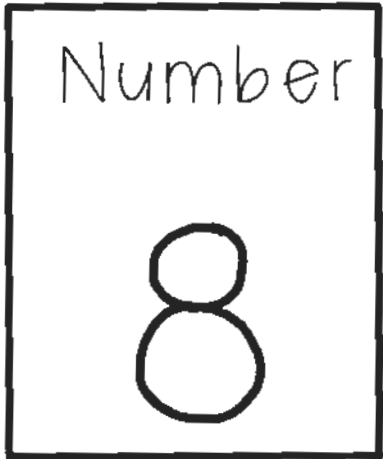

1. Trace



2. Write.

3. Color.



4. Circle.

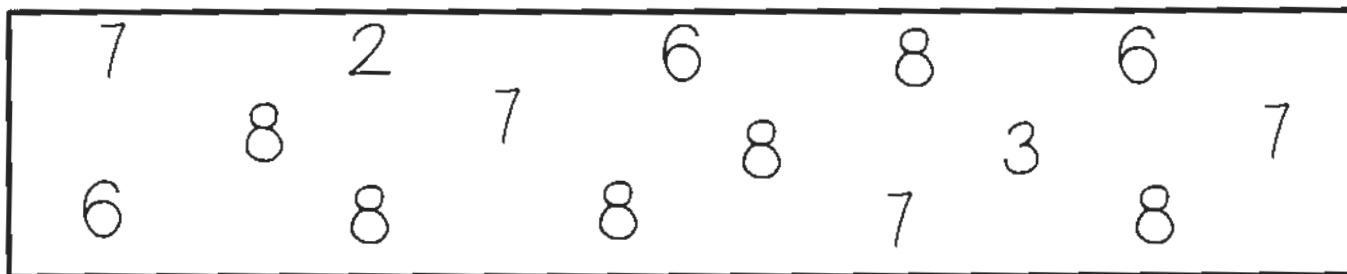

5. Color the squares to show the number 8 in the 10 frame.

| | | | | |
|--|--|--|--|--|
| | | | | |
| | | | | |

Name: _____

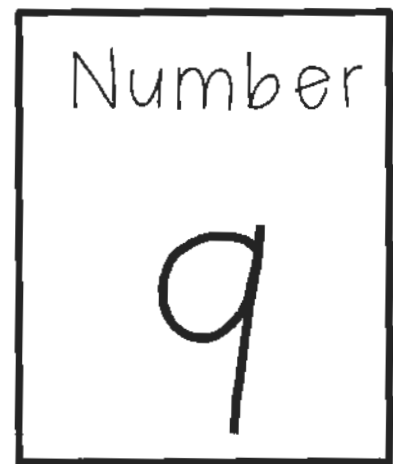

1. Trace



2. Write.

3. Color.



4. Circle.

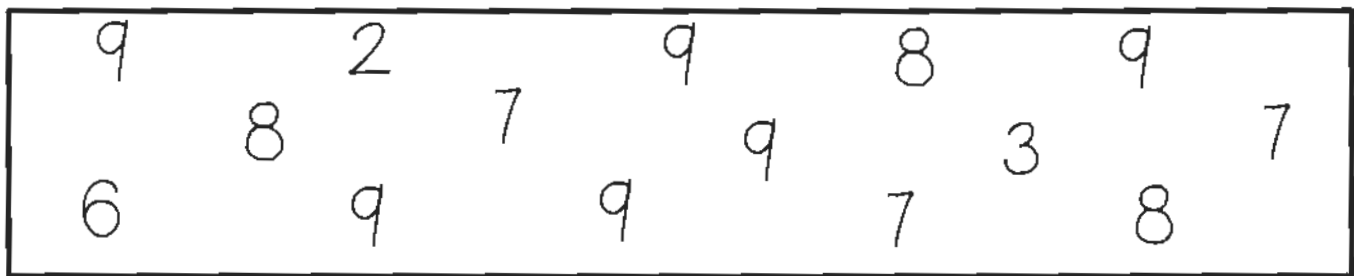

5. Color the squares to show the number 9 in the 10 frame.

| | | | | |
|--|--|--|--|--|
| | | | | |
| | | | | |

Name: _____

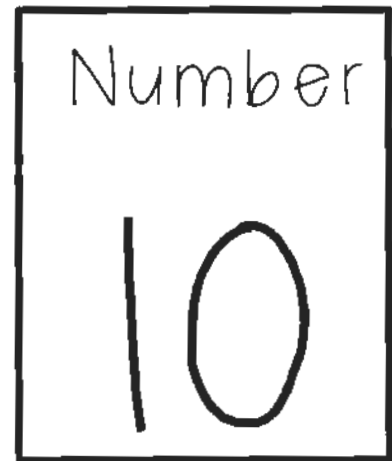

1. Trace

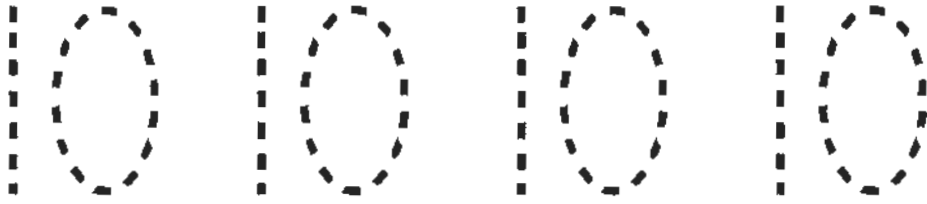

2. Write.

3. Color.



4. Circle.

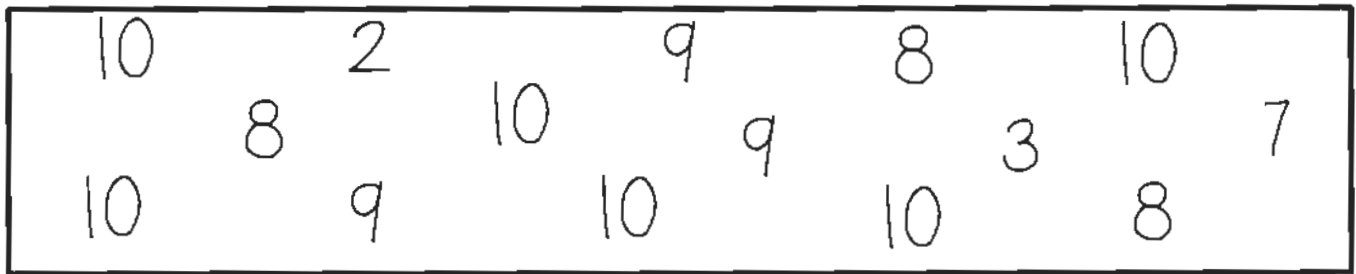

5. Color the squares to show the number 10 in the 10 frame.

| | | | | |
|--|--|--|--|--|
| | | | | |
| | | | | |

Letter A:

The Apple Pie Tree by Zoe Hall
Are you an Ant by Judy Allen
Ten Apples Up on Top by Dr. Seuss
Ant Cities by Arthur Dorros
Apples, Apples! By Salina Yoon
Apples and How They Grow by Laura Driscoll
Apples by Gail Gibbons
Apple Seasons by Gail Gibbons
How Do Apples Grow? by Betsy Maestro

Letter B:

Busy Butterflies by Wendy McLean
Brown Bear, Brown Bear, What Do You See? by Bill Martin Jr
Baby Bear, Baby Bear, What Do You See? by Bill Martin Jr
The Berenstain Bears' Big Bedtime Book by Jan Berenstain
From Caterpillar to Butterfly by Deborah Heiligman
The Butterfly Alphabet by Kjell B Sandved
The Butterfly Alphabet Book by Brian Cassie
My, Oh My—A Butterfly! By Dr. Seuss
Caterpillar to Butterfly by Sally Symes
Bedtime for Francis by Russell Hoban

Letter C:

The Very Hungry Caterpillar by Eric Carle
The Very Hungry Caterpillar's Favorite Words by Eric Carle
Count with The Very Hungry Caterpillar by Eric Carle
Caps for Sale by Esphyr Slobodkina
Charlie the Caterpillar by Dom Deluise
The Goodnight Caterpillar by Lori Lite
Caterpillar Wings by Kimberly Owen
From Caterpillar to Butterfly by Deborah Heiligman
Caterpillar to Butterfly by Sally Symes
Greatest Heroes: Joseph & the Coat of Many Colors
Coat of Many Colors by Dolly Parton

Letter D:

Dinosaurumpus! by Tony Mitton

How Do Dinosaurs Clean Their Rooms? by Jane Yolen

How Do Dinosaurs Say Goodnight? by Jane Yolen

How Do Dinosaurs Say I Love You? by Jane Yolen

How Do Dinosaurs Play With Their Friends? by Jane Yolen

Dinosaurs Galore! by Giles Andreae

Rumble in the Jungle by Giles Andreae

Letter E:

Green Eggs and Ham by Dr Seuss

Elephants by Steve Bloom

Sesame Street ABCs Letter E by Diane Ohanesian

Edna Elephant by Margaret Park Bridges

Barbar's Counting Book by Laurent De Brunhoff

The Story Of Barbar by Jean De Brunhoff

The Saggy Baggy Elephant by Kathryn Jackson

Letter F:

Rainbow Fish Counting by Marcus Pfister

Rainbow Fish by Marcus Pfister

Rainbow Fish ABC by Marcus Pfister

Rainbow Fish Colors by Marcus Pfister

One Fish, Two Fish, Red Fish, Blue Fish by Dr. Seuss

The Pout-Pout Fish by Deborah Diesen

How Many Fish? By Caron Lee Cohen

Letter G:

Good Night God by Holly Bea

Good Night Gorilla by Peggy Rathmann

The Bubble Gum Kid by Stu Smith

Franklin and the Bubble Gum by Sean Jeffrey

Guess How Much I Love You? by LeapFrog

Giraffes Can't Dance by Giles Andreae

The Bubble Gum Christmas by Lucille E Sette

Bubble Gum, Bubble Gum by Lisa Wheeler

Letter H:

Horton Hears a Who! By Dr. Seuss
The Hiccupping Hippo by Keith Faulkner
Hattie Hippo by Christine Loomis
Hippos Go Berserk by Sandra Boynton
House for Hermit Crab by Eric Carle
Hungry Hungry Hippos by Hasbro

Letter I:

Inchworm and A Half by Elinor J Pinczes
Inch by Inch by Leo Lionni
If you Take a Mouse To School by Laura Numeroff
If You Give A Pig A Party by Laura Numeroff
If You Give A Pig A Pancake by Laura Numeroff
If You Give A Moose A Muffin by Laura Numeroff
If You Give a Cat a Cupcake by Laura Numeroff

Letter J:

Jesus, Me, and My Christmas Tree by Crystal Bowman
Christmas in the Manger by Felicia Bond
NirV Read With Me Bible by Zondervan
J is for Jesus by Crystal Bowman
The Christmas Story by Jane Werner Watson
The ADVENTure Of Christmas by Lisa Whelchel
No Room at the Inn by Jean M. Malone
A Star for Jesus by Crystal Bowman
Little Kids Adventure Bible by Lawrence O. Richards
The Nativity Story by DK Publishing

Letter K:

The Kissing Monster by Marion Dane Bauer
Three Little Kittens by Paul Galdone
Kippers Kite by Mick Inkpen
Let's Fly A Kite by Stuart J. Murphy
Counting Kisses by Karen Katz

Letter L:

Lydia Ladybug Earned her Wings by Marie Lawrence
Lydia The Ladybug In Paris by Marie Lawrence
Ten Little Ladybugs by Melanie Gerth
Little Ladybug Finger Puppet Book by Chronicle Books
The Grouchy Ladybug by Eric Carle
Ladybug Girl by Jacky Davis
Are You a Ladybug? by Judy Allen

Letter M:

The m&m's Counting Book by Barbara Barbieri McGrath
If You Give A Moose A Muffin by Laura Numeroff
If You Give a Mouse a Cookie by Laura Numeroff
Moosetache by Margie Palatini
Mooseltoe by Margie Palatini
Mary Had a Little Jan and Other Silly Rhymes by Bruce Lansky

Letter N:

The Best Nest by P.D. Eastman
Finding Nemo by Amy J. Tyler
In My Nest by Sara Gillingham
A Nest Full of Eggs by Priscilla Belz Jenkins
Birds, Nests & Eggs by Mel Boring

Letter O:

Owl Moon by Jane Yolen
Owl Babies by Martin Waddell
Have You Ever Seen an Octopus with a Broom? by Etta Kaner
Angry Octopus: A Relaxation Story by Lori Lite
The Owl and the Pussycat by Edward Lear
Good-Night Owl! by Pat Hutchins

Letter P:

The Story About Ping by Marjorie Flack
If You Give A Pig A Party by Laura Numeroff
The Pumpkin Patch Parable by Liz Curtis Higgs
The Pine Tree Parable by Liz Curtis Higgs
My Thanksgiving Prayer by Crystal Bowman
My Happy Pumpkin by by Crystal Bowman
Too Many Pumpkins by Linda White
Duck & Goose Find A Pumpkin by Tad Hills
Pumpkin Town! by Katie McKy
From Seed to Pumpkin by Wendy Pfeffer
The Runaway Pumpkin by Kevin Lewis

Letter Q:

Eight Hands Round: A Patchwork Alphabet by Ann Whitford Paul
The Name Quilt by Phyllis Root
The Quiltmaker's Gift by Jeff Brumbeau
Thump, Quack, Moo by Doreen Cronin
Quick, Quack, Quick! by Marsha Arnold
Giggle, Giggle, Quack by Doreen Cronin
The Josefina Story Quilt by Eleanor Coerr
The Rag Coat by Lauren A Mills

Letter R:

What Makes a Rainbow? By Betty Ann Schwartz
Rainbow Fish Opposites by Marcus Pfister Herbert
Rainbow Sheep by Kim Chatel
Planting a Rainbow by Lois Ehlert
The Runaway Bunny by Margaret Wise Brown
Rainbow Fish by Marcus Pfister
Rainbow Fish Counting by Marcus Pfister
Rainbow Fish ABC by Marcus Pfister
Rainbow Fish Colors by Marcus Pfister

Letter S:

The Snowy Day by Ezra Jack Keats
That's Not My Snowman by Fiona Watt
Biggest, Best Snowman by Margery Cuyler
The Little Snowman: Finger Puppet Book by ImageBooks
The First Day of Winter by Denise Fleming
Frosty the Snowman by Jack Rollins
The Snowman by Raymond Briggs
The Biggest Snowman Ever by Steven Kroll

Letter T:

One Tiny Turtle by Nicola Davies
Turtle Splash! Countdown at the Pond by Cathryn Falwell
Tiny Turtles (Button Counting Book) by Wendy McLean
Trent the Racing Turtle by Bill Franklin
Yertle the Turtle by Dr. Seuss
How the Turtle Got Its Shell by Justine Fontes
Emma's Turtle by Eve Bunting
Ten Tiny Turtles: Counting Book by Paul Cherrill
Sea Turtles by Mary Jo Rhodes

Letter U:

Alpha Tales Umbrellabird's Umbrella by Heather Feldman
Katie and the Magic Umbrella by Kristine Kahane
Under My Umbrella by Susan Hood
Underwater Counting by Jerry Pallotta
Leapfrog Letter Factory by Roy Allen Smith

Letter V:

My Valentine Story by Crystal Bowman
Alpha Tales Vera Viper's Valentine by Maxwell Higgins
Snuggle Puppy A Love Song by Sandra Boynton
The Berenstain Bears Funny Valentine by Stan Berenstain
The Valentine Bears by Eve Bunting
Elmo: My Fuzzy Valentine by Naomi Kleinberg

Happy Valentine's Day, Mouse! by Laura Numeroff

Letter W:

Cloudy With A Chance of Meatballs by Judi Barrett

Where the Wild Things Are by Maurice Sendak

Wacky Wednesday by Dr. Seuss

The Whingdingdilly by Bill Peet

Brown Bear, Brown Bear, What Do You See? By Bill Martin Jr.

Alpha Tales: Worm's Wagon by Samantha Berger

Letter X:

Alpha Tales: A Xylophone for X-ray Fish by Liza Charlesworth

Cooper Gets an X-Ray by Karen Olson

Jessica's X-Ray by Pat Zonta

A Fox: The Sound of X by Alice K. Flanagan

Melissa & Doug Xylophone

Letter Y:

Alpha Tales The Yak Who Yelled Yuck by Carol Pugliano-Martin

You and Me, Little Bear by Martin Waddell

God Loves You Very Much: Veggie Tales

Veggie Tales: Are You My Neighbor?: Veggie Tales

Leapfrog Letter Factory

Letter Z:

Welcome to the Zoo by Alison Jay

What Will I Do When I'm New At The Zoo by Amy Miller

Zebras by Jill Anderson

How the Zebra Got Its Stripes by Golden Books

What If The Zebra's Lost Their Stripes! by John Reitano

On Beyond Zebra! by Dr. Seuss

An A to Z Walk in the Park by R.M. Smith

Curious George Visits The Zoo by Margret Rey

Name: _____ Date: _____

Alphabet Scavenger Hunt

| | |
|---|---|
| A | N |
| B | O |
| C | P |
| D | Q |
| E | R |
| F | S |
| G | T |
| H | U |
| I | V |
| J | W |
| K | X |
| L | Y |
| M | Z |

50 Free Fine Motor Activity Ideas for Children Ages 3-6

Bilateral Coordination Skills

1. Use peg boards
2. Rainbow Lacing Busy Bag
3. Building with Legos ®
4. Tear lettuce into pieces for a salad
5. Tear construction paper for a collage
6. Peeling stickers
7. Spread icing on cookies or cupcakes
8. Use both arms to twirl streamers
9. Making bead necklaces or bracelets
10. Putting up to 12 piece puzzles together

Pre-Writing Skills

21. Use clothespins to pick up objects
22. Fruit Loop Pincer Grasp Activity
23. Form letters with wikki stix
24. Pipe Cleaner Pincer Grasp Activity
25. Form lines and shapes with pipe cleaners

Scissor Skills

11. Guess the shape cutting activity
12. Complete 4-6 turn mazes
13. Cut out circle, triangle, and square shapes
14. Stick people activity
15. Folding paper into fourths
16. Cutting with crinkle cut or design scissors
17. Threading Buttons
18. Rainbow Matching Collage
19. Cutting yarn
20. Cutting practice spider
26. Use fine motor tweezers or tongs to pick up objects
27. Trace letters in shaving cream
28. Sensory Shape Tracing
29. Use letter stamps to form their name
30. String letter beads on string to form their name

General Fine Motor Skills

31. Lacing cards
32. Button or unbutton large buttons on clothing or button board
33. Drawing a person with at least 6 body parts included
34. Learn to tie their shoes
35. Build complex shapes (towers, bridges, pyramids, etc) with blocks
36. Screwing various size lids onto containers
37. Practice coloring within the lines
38. Tracing around their own hand with a pencil or crayon
39. Reeling a fishing pole.
40. Simple food preparation (measuring, stirring, cutting soft items with a butter knife)

Sensory Fine Motor Skills

41. Sensory Bins
42. Finger Painting (Homemade Recipe, Cinnamon or Peppermint)
43. Popping Large Bubble Wrap (more Large Bubble Wrap ideas)
45. Playing with bread dough (2 Ingredient Recipe)
46. Planting flowers or plants in a garden
47. Drawing in sand
48. Washing dishes
49. Drawing or tracing in couscous, rice, lentils etc.
50. Playing with musical instruments (drum, piano, violin, recorder, etc)